

PS 350



Condensadores

Los condensadores están fabricados con una carrocería de chapa galvanizada y lacada en blanco o inoxidable bajo pedido.



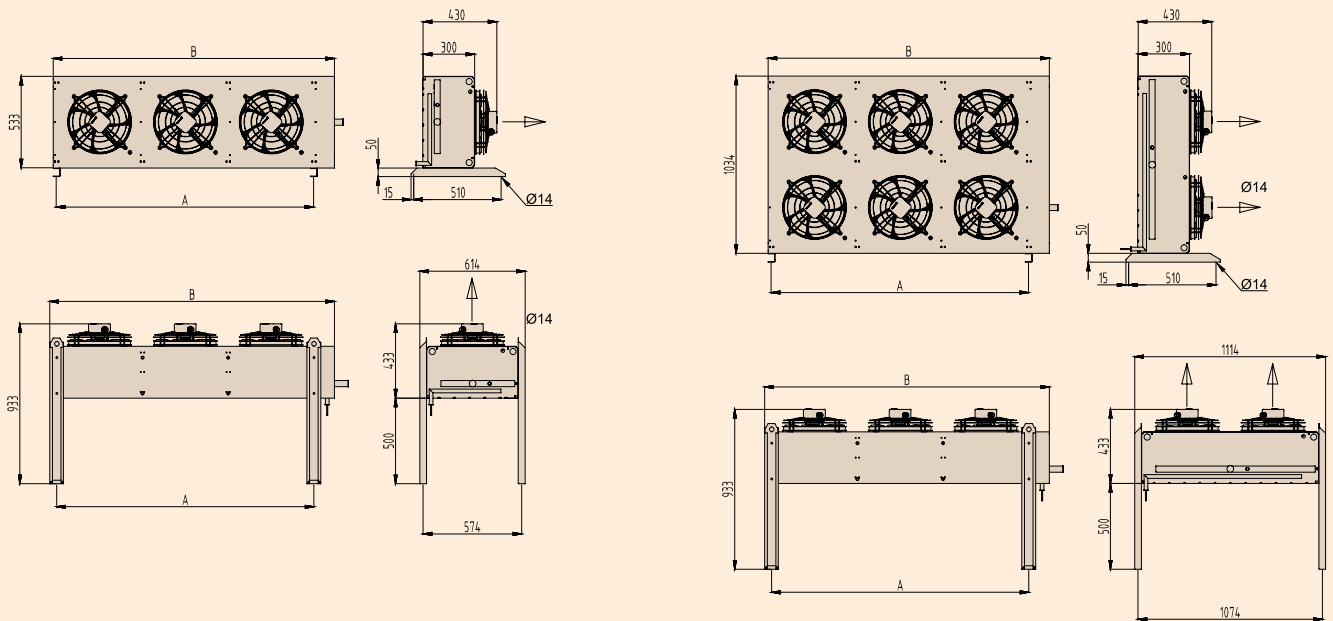

La batería está realizada con tubo de cobre de \varnothing 8mm y aleta de aluminio con paso de aleta 2.1 mm.

Los ventiladores son monofásicos para las series 350; 450 y trifásicos para la serie 500.

Dimensiones



Modelo	Ventiladores	A	B
PS-L3 11		500	640
PS-L3 12		1000	1140
PS-L3 13		1500	1640
PS-L3 14		2000	2140

Modelo	Ventiladores	A	B
PS-L3 21		500	640
PS-L3 22		1000	1140
PS-L3 23		1500	1640
PS-L3 24		2000	2140

Datos y precios

Ø 350 mm

Modelo	Flujo Horiz.	Flujo Vert.	R449A	R134A	Caudal aire m³/h	Superf. m²	Vol. interno dm³	Nº Vent.	Abs. nominal A	Cons. nominal Kw	Nivel Sonoro		Peso Kg	IN Ø"	OUT Ø"
	P.V.P.	P.V.P.	Cap. Nominal ΔT=15K	Cap. Nominal ΔT=15K							10 m	5 m			
4 polos - 1400 rpm															
PS3112	539 €	590 €	5,46	5,70	2.850	10,30	1,00	1	0,70	0,15	40	46	13	7/8	3/4
PS3113	623 €	674 €	7,28	7,61	2.650	15,40	1,50	1	0,70	0,15	40	46	15	7/8	3/4
PS3114	676 €	726 €	8,58	8,97	2.450	20,50	1,90	1	0,70	0,15	40	46	17	7/8	3/4
PS3115	728 €	779 €	9,32	9,74	2.250	25,70	2,40	1	0,70	0,15	40	46	19	7/8	3/4
PS3122	966 €	1.017 €	10,90	11,39	5.700	19,80	2,00	2	1,40	0,29	43	49	26	7/8	3/4
PS3123	1.074 €	1.124 €	14,48	15,13	5.300	30,80	3,00	2	1,40	0,29	43	49	30	7/8	3/4
PS3124	1.180 €	1.230 €	17,07	17,84	4.900	41,00	3,80	2	1,40	0,29	43	49	34	1-1/8	7/8
PS3125	1.287 €	1.337 €	18,54	19,37	4.500	51,40	4,80	2	1,40	0,29	43	49	38	1-1/8	3/4
PS3133	1.547 €	1.622 €	21,76	22,74	7.950	46,20	4,50	3	2,10	0,44	45	51	45	1-1/8	7/8
PS3134	1.719 €	1.794 €	25,66	26,81	7.350	61,50	5,70	3	2,10	0,44	45	51	51	1-1/8	7/8
PS3135	1.891 €	1.966 €	27,86	29,11	6.750	77,10	7,20	3	2,10	0,44	45	51	57	1-1/8	7/8
PS3143	2.019 €	2.094 €	28,95	30,25	10.600	61,60	6,00	4	2,80	0,58	46	52	60	1-3/8	7/8
PS3144	2.257 €	2.332 €	34,24	35,78	9.800	82,00	7,60	4	2,80	0,58	46	52	68	1-3/8	7/8
PS3145	2.495 €	2.570 €	37,08	38,74	9.000	102,80	9,60	4	2,80	0,58	46	52	76	1-3/8	7/8
PS3223	2.004 €	2.080 €	28,95	30,25	10.600	61,60	6,00	4	2,80	0,58	46	52	60	1-3/8	7/8
PS3224	2.225 €	2.301 €	34,24	35,78	9.800	82,00	7,60	4	2,80	0,58	46	52	68	1-3/8	7/8
PS3225	2.446 €	2.521 €	37,08	38,74	9.000	102,80	9,60	4	2,80	0,58	46	52	76	1-3/8	1-1/8
PS3233	2.967 €	3.068 €	43,52	45,48	15.900	92,40	9,00	6	4,20	0,87	48	54	90	1-3/8	1-1/8
PS3234	3.310 €	3.410 €	51,31	53,61	14.700	123,00	11,40	6	4,20	0,87	48	54	102	1-3/8	1-1/8
PS3235	3.653 €	3.753 €	55,63	58,13	13.500	154,20	14,40	6	4,20	0,87	48	54	114	1-3/8	1-1/8
PS3243	3.930 €	4.030 €	59,47	62,14	21.200	123,20	12,00	8	5,60	1,16	50	56	120	1-5/8	1-1/8
PS3244	4.396 €	4.496 €	70,53	73,70	19.600	164,00	15,20	8	5,60	1,16	50	56	136	1-5/8	1-1/8
PS3245	4.862 €	4.962 €	76,40	79,83	18.000	205,60	19,20	8	5,60	1,16	50	56	152	1-5/8	1-3/8
6 polos - 920 rpm															
PSL3112	539 €	590 €	3,82	3,99	1.850	9,90	1,40	1	0,35	0,08	30	36	13	7/8	3/4
PSL3113	623 €	674 €	5,71	5,97	1.700	14,80	2,10	1	0,35	0,08	30	36	15	7/8	3/4
PSL3114	676 €	726 €	6,53	6,83	1.550	19,80	2,80	1	0,35	0,08	30	36	17	7/8	3/4
PSL3115	728 €	779 €	6,90	7,21	1.400	24,70	3,50	1	0,35	0,08	30	36	19	7/8	3/4
PSL3122	966 €	1.017 €	8,91	9,31	3.700	19,80	2,80	2	0,70	0,15	33	39	26	7/8	3/4
PSL3123	1.074 €	1.124 €	11,44	11,95	3.400	29,60	4,20	2	0,70	0,15	33	39	30	7/8	3/4
PSL3124	1.180 €	1.230 €	13,07	13,65	3.100	39,60	5,60	2	0,70	0,15	33	39	34	7/8	3/4
PSL3125	1.287 €	1.337 €	13,79	14,41	2.800	49,40	7,00	2	0,70	0,15	33	39	38	1-1/8	3/4
PSL3133	1.547 €	1.622 €	17,24	18,01	5.100	44,40	6,30	3	1,05	0,23	35	41	45	1-1/8	7/8
PSL3134	1.719 €	1.794 €	19,69	20,57	4.650	59,40	8,40	3	1,05	0,23	35	41	51	1-1/8	7/8
PSL3135	1.891 €	1.966 €	20,77	21,71	4.200	74,10	10,50	3	1,05	0,23	35	41	57	1-1/8	7/8
PSL3143	2.019 €	2.094 €	22,96	23,99	6.800	59,20	8,40	4	1,40	0,30	36	42	60	1-3/8	7/8
PSL3144	2.257 €	2.332 €	26,22	27,40	6.200	79,20	11,20	4	1,40	0,30	36	42	68	1-3/8	7/8
PSL3145	2.495 €	2.570 €	27,67	28,91	5.600	98,80	14,00	4	1,40	0,30	36	42	76	1-3/8	7/8
PSL3223	2.004 €	2.080 €	22,96	23,99	6.800	59,20	8,40	4	1,40	0,30	36	42	60	1-3/8	7/8
PSL3224	2.225 €	2.301 €	26,22	27,40	6.200	79,20	11,20	4	1,40	0,30	36	42	68	1-3/8	7/8
PSL3225	2.446 €	2.521 €	27,67	28,91	5.600	98,80	14,00	4	1,40	0,30	36	42	76	1-3/8	7/8
PSL3233	2.967 €	3.068 €	34,39	35,94	10.200	88,80	12,60	6	2,10	0,45	38	44	90	1-3/8	7/8
PSL3234	3.310 €	3.410 €	39,28	41,04	9.300	118,80	16,80	6	2,10	0,45	38	44	102	1-3/8	1-1/8
PSL3235	3.653 €	3.753 €	41,46	43,32	8.400	148,20	21,00	6	2,10	0,45	38	44	114	1-3/8	1-1/8
PSL3243	3.930 €	4.030 €	43,06	44,99	13.600	118,40	16,80	8	2,80	0,60	40	46	120	1-5/8	1-1/8
PSL3244	4.396 €	4.496 €	50,75	53,03	12.400	158,40	22,40	8	2,80	0,60	40	46	136	1-5/8	1-1/8
PSL3245	4.862 €	4.962 €	53,48	55,88	11.200	197,60	28,00	8	2,80	0,60	40	46	152	1-5/8	1-1/8

Opcionales

Código	ALE PRE	ALE HYD	ALE CU	EVP FRS	CHA AISI304	VENT EC	Código	ALE PRE	ALE HYD	ALE CU	EVP FRS	CHA AISI304	VENT EC
3112	117 €	117 €	287 €	338 €	no disp	440 €	3144	230 €	230 €	1.588 €	1.383 €	no disp	1.759 €
3113	124 €	124 €	379 €	412 €	no disp	440 €	3145	261 €	261 €	1.960 €	1.681 €	no disp	1.759 €
3114	133 €	133 €	472 €	487 €	no disp	440 €	3223	195 €	195 €	1.190 €	1.063 €	no disp	1.759 €
3115	141 €	141 €	565 €	562 €	no disp	440 €	3224	226 €	226 €	1.553 €	1.354 €	no disp	1.759 €
3122	133 €	133 €	472 €	487 €	no disp	880 €	3225	258 €	258 €	1.916 €	1.646 €	no disp	1.759 €
3123	148 €	148 €	658 €	636 €	no disp	880 €	3233	243 €	243 €	1.735 €	1.500 €	no disp	2.639 €
3124	165 €	165 €	844 €	786 €	no disp	880 €	3234	289 €	289 €	2.279 €	1.937 €	no disp	2.639 €
3125	181 €	181 €	1.030 €	935 €	no disp	880 €	3235	337 €	337 €	2.825 €	2.374 €	no disp	2.639 €
3133	173 €	173 €	937 €	860 €	no disp	1.319 €	3243	289 €	289 €	2.279 €	1.937 €	no disp	3.518 €
3134	197 €	197 €	1.216 €	1.084 €	no disp	1.319 €	3244	352 €	352 €	3.006 €	2.520 €	no disp	3.518 €
3135	221 €	221 €	1.495 €	1.308 €	no disp	1.319 €	3245	415 €	415 €	3.732 €	3.103 €	no disp	3.518 €
3143	197 €	197 €	1.216 €	1.084 €	no disp	1.759 €							

PS 450



Condensadores





Los condensadores están fabricados con una carrocería de chapa galvanizada y lacada en blanco o inoxidable bajo pedido.



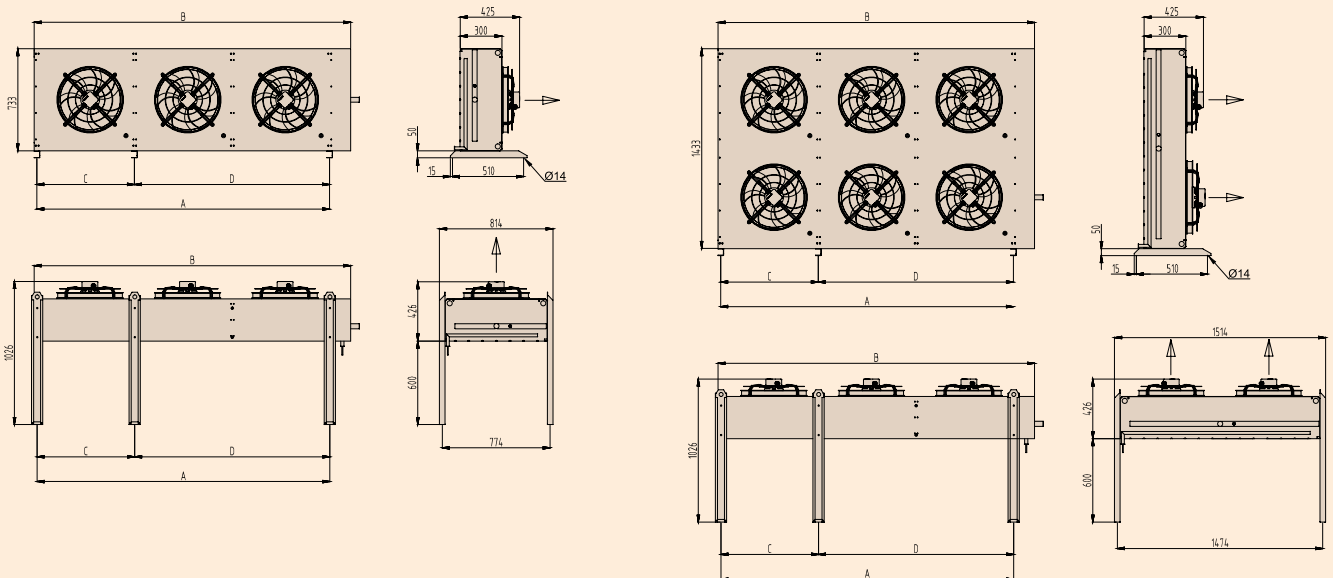

La batería está realizada con tubo de cobre de \varnothing 8mm y aleta de aluminio con paso de aleta 2.1 mm.

Los ventiladores son monofásicos para las series 350; 450 y trifásicos para la serie 500.

Dimensiones

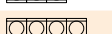

Modelo	Ventiladores	A	B	C	D
PS-L4 11		700	870	-	-
PS-L4 12		1400	1570	-	-
PS-L4 13		2100	2270	-	-
PS-L4 14		2800	2970	-	-
PS-L4 15		3500	3670	1400	2100

Modelo	Ventiladores	A	B	C	D
PS-L4 21		700	870	-	-
PS-L4 22		1400	1570	-	-
PS-L4 23		2100	2270	-	-
PS-L4 24		2800	2970	-	-
PS-L4 25		3500	3670	1400	2100

Datos y precios

Ø 450 mm

Modelo	Flujo Horiz.	Flujo Vert.	R449A	R134A	Caudal aire m³/h	Superf. m²	Vol. interno dm³	Nº Vent.	Abs. nominal A	Cons. nominal Kw	Nivel Sonoro		Peso Kg	IN Ø"	OUT Ø"
	P.V.P.	P.V.P.	Cap. Nominal ΔT=15K	Cap. Nominal ΔT=15K							10 m	5 m			
4 polos - 1400 rpm															
PS4112	1.097 €	1.147 €	10,86	11,35	4.800	20,10	1,90	1	2,36	0,49	49	55	31	1-1/8	3/4
PS4113	1.207 €	1.257 €	13,97	14,60	4.600	30,20	2,80	1	2,36	0,49	49	55	34	1-1/8	3/4
PS4114	1.309 €	1.359 €	15,93	16,65	4.400	40,30	3,80	1	2,36	0,49	49	55	37	1-1/8	3/4
PS4115	1.413 €	1.463 €	17,18	17,95	4.200	50,30	4,70	1	2,36	0,49	49	55	40	1-1/8	3/4
PS4122	1.746 €	1.796 €	21,98	22,97	9.600	40,20	3,80	2	4,72	0,98	52	58	62	1-1/8	7/8
PS4123	1.918 €	1.968 €	28,30	29,57	9.200	60,40	5,60	2	4,72	0,98	52	58	68	1-3/8	7/8
PS4124	2.095 €	2.145 €	32,13	33,57	8.800	80,60	7,60	2	4,72	0,98	52	58	74	1-3/8	7/8
PS4125	2.291 €	2.341 €	34,62	36,18	8.400	100,60	9,40	2	4,72	0,98	52	58	80	1-3/8	7/8
PS4133	2.762 €	2.837 €	42,45	44,36	13.800	90,60	8,40	3	7,08	1,47	53	59	102	1-3/8	1-1/8
PS4134	3.018 €	3.094 €	48,15	50,31	13.200	120,90	11,40	3	7,08	1,47	53	59	111	1-3/8	1-1/8
PS4135	3.305 €	3.380 €	51,89	54,22	12.600	150,90	14,10	3	7,08	1,47	53	59	120	1-3/8	1-1/8
PS4143	3.662 €	3.763 €	56,60	59,15	18.400	120,80	11,20	4	9,44	1,96	55	61	136	1-5/8	1-1/8
PS4144	4.006 €	4.107 €	64,26	67,15	17.600	161,20	15,20	4	9,44	1,96	55	61	148	1-5/8	1-1/8
PS4145	4.388 €	4.489 €	69,24	72,35	16.800	201,20	18,80	4	9,44	1,96	55	61	160	1-5/8	1-1/8
PS4153	4.568 €	4.668 €	70,67	73,84	23.000	151,00	14,00	5	11,80	2,45	56	62	170	1-5/8	1-3/8
PS4154	4.993 €	5.094 €	80,28	83,89	22.000	201,50	19,00	5	11,80	2,45	56	62	185	1-5/8	1-3/8
PS4155	5.469 €	5.570 €	86,51	90,40	21.000	251,50	23,50	5	11,80	2,45	56	62	200	1-5/8	1-3/8
PS4223	3.776 €	3.851 €	56,60	59,15	18.400	120,80	11,20	4	14,16	2,94	55	61	136	1-5/8	1-1/8
PS4224	4.130 €	4.205 €	64,26	67,15	17.600	161,20	15,20	4	14,16	2,94	55	61	148	1-5/8	1-1/8
PS4225	4.521 €	4.597 €	69,24	72,35	16.800	201,20	18,80	4	14,16	2,94	55	61	160	1-5/8	1-1/8
PS4233	5.469 €	5.570 €	84,82	88,63	27.600	181,20	16,80	6	16,52	3,43	57	63	204	1-5/8	1-3/8
PS4234	5.980 €	6.081 €	96,39	100,72	26.400	241,80	22,80	6	16,52	3,43	57	63	222	1-5/8	1-3/8
PS4235	6.551 €	6.652 €	103,86	108,53	25.200	301,80	28,20	6	16,52	3,43	57	63	240	1-5/8	1-3/8
PS4243	7.271 €	7.372 €	113,12	118,20	36.800	241,60	22,40	8	18,88	3,92	59	65	272	2-1/8	1-3/8
PS4244	7.956 €	8.056 €	128,52	134,29	35.200	322,40	30,40	8	18,88	3,92	59	65	296	2-1/8	1-3/8
PS4245	8.713 €	8.814 €	138,48	144,71	33.600	402,40	37,60	8	18,88	3,92	59	65	320	2-1/8	1-5/8
PS4253	9.073 €	9.199 €	141,42	147,78	46.000	302,00	28,00	10	21,24	4,41	59	65	340	2-1/8	1-5/8
PS4254	9.926 €	10.052 €	160,65	167,87	44.000	403,00	38,00	10	21,24	4,41	59	65	370	2-1/8	1-5/8
PS4255	10.878 €	11.003 €	186,90	195,30	48.900	513,00	48,00	10	21,24	4,41	59	65	400	2-1/8	1-5/8
6 polos - 900 rpm															
PSL4112	1.097 €	1.147 €	8,99	9,39	3.450	20,10	1,90	1	0,86	0,19	39	45	31	1-1/8	3/4
PSL4113	1.207 €	1.257 €	11,21	11,72	3.300	30,20	2,80	1	0,86	0,19	39	45	34	1-1/8	3/4
PSL4114	1.309 €	1.359 €	12,55	13,11	3.150	40,30	3,80	1	0,86	0,19	39	45	37	1-1/8	3/4
PSL4115	1.413 €	1.463 €	13,35	13,95	3.000	50,30	4,70	1	0,86	0,19	39	45	40	1-1/8	3/4
PSL4122	1.746 €	1.796 €	18,07	18,88	6.900	40,20	3,80	2	1,72	0,38	42	48	62	1-3/8	7/8
PSL4123	1.918 €	1.968 €	22,70	23,72	6.600	60,40	5,60	2	1,72	0,38	42	48	68	1-3/8	7/8
PSL4124	2.095 €	2.145 €	25,37	26,51	6.300	80,60	7,60	2	1,72	0,38	42	48	74	1-3/8	7/8
PSL4125	2.291 €	2.341 €	26,88	28,09	6.000	100,60	9,40	2	1,72	0,38	42	48	80	1-3/8	7/8
PSL4133	2.762 €	2.837 €	33,91	35,43	9.900	90,60	8,40	3	2,58	0,57	43	49	102	1-3/8	1-1/8
PSL4134	3.018 €	3.094 €	38,00	39,71	9.450	120,90	11,40	3	2,58	0,57	43	49	111	1-3/8	1-1/8
PSL4135	3.305 €	3.380 €	40,41	42,22	9.000	150,90	14,10	3	2,58	0,57	43	49	120	1-3/8	1-1/8
PSL4143	3.662 €	3.763 €	45,21	47,24	13.200	120,80	11,20	4	3,44	0,76	45	51	136	1-5/8	1-1/8
PSL4144	4.006 €	4.107 €	50,64	52,92	12.600	161,20	15,20	4	3,44	0,76	45	51	148	1-5/8	1-1/8
PSL4145	4.388 €	4.489 €	53,85	56,27	12.000	201,20	18,80	4	3,44	0,76	45	51	160	1-5/8	1-1/8
PSL4153	4.568 €	4.668 €	56,60	59,15	16.500	151,00	14,00	5	4,30	0,95	46	52	170	1-5/8	1-3/8
PSL4154	4.993 €	5.094 €	63,37	66,22	15.750	201,50	19,00	5	4,30	0,95	46	52	185	1-5/8	1-3/8
PSL4155	5.469 €	5.570 €	67,28	70,31	15.000	251,50	23,50	5	4,30	0,95	46	52	200	1-5/8	1-3/8
PSL4223	3.776 €	3.851 €	45,21	47,24	13.200	120,80	11,20	4	5,16	1,14	45	51	136	1-5/8	1-1/8
PSL4224	4.130 €	4.205 €	50,64	52,92	12.600	161,20	15,20	4	5,16	1,14	45	51	148	1-5/8	1-1/8
PSL4225	4.521 €	4.597 €	53,85	56,27	12.000	201,20	18,80	4	5,16	1,14	45	51	160	1-5/8	1-1/8
PSL4233	5.469 €	5.570 €	67,91	70,96	19.800	181,20	16,80	6	6,02	1,33	47	53	204	1-5/8	1-3/8
PSL4234	5.980 €	6.081 €	76,01	79,42	18.900	241,80	22,80	6	6,02	1,33	47	53	222	1-5/8	1-3/8
PSL4235	6.551 €	6.652 €	80,72	84,35	18.000	301,80	28,20	6	6,02	1,33	47	53	240	1-5/8	1-3/8
PSL4243	7.271 €	7.372 €	90,51	94,58	26.400	241,60	22,40	8	6,88	1,52	49	55	272	2-1/8	1-3/8
PSL4244	7.956 €	8.056 €	101,37	105,93	25.200	322,40	30,40	8	6,88	1,52	49	55	296	2-1/8	1-3/8
PSL4245	8.713 €	8.814 €	107,69	112,53	24.000	402,40	37,60	8	6,88	1,52	49	55	320	2-1/8	1-5/8
PSL4253	9.073 €	9.199 €	113,12	118,20	33.000	302,00	28,00	10	7,74	1,71	49	55	340	2-1/8	1-5/8
PSL4254	9.926 €	10.052 €	126,74	132,43	31.500	403,00	38,00	10	7,74	1,71	49	55	370	2-1/8	1-5/8
PSL4255	10.878 €	11.003 €	134,57	140,62	30.000	503,00	47,00	10	7,74	1,71	49	55	400	2-5/8	1-5/8

Opcionales

Código	ALE PRE	ALE HYD	ALE CU	EVP FRS	CHA AISI304	VENTEC	Código	ALE PRE	ALE HYD	ALE CU	EVP FRS	CHA AISI304	VENTEC
4112	132 €	132 €	460 €	477 €	no disp	1.194 €	4153	334 €	334 €	2.797 €	2.353 €	no disp	5.969 €
4113	147 €	147 €	640 €	621 €	no disp	1.194 €	4154	412 €	412 €	3.697 €	3.075 €	no disp	5.969 €
4114	163 €	163 €	819 €	766 €	no disp	1.194 €	4155	490 €	490 €	4.595 €	3.796 €	no disp	5.969 €
4115	178 €	178 €	999 €	910 €	no disp	1.194 €	4223	284 €	284 €	2.220 €	1.890 €	no disp	4.524 €
4122	163 €	163 €	819 €	766 €	no disp	2.388 €	4224	346 €	346 €	2.928 €	2.458 €	no disp	4.524 €
4123	194 €	194 €	1.180 €	1.054 €	no disp	2.388 €	4225	407 €	407 €	3.634 €	3.025 €	no disp	4.524 €
4124	225 €	225 €	1.539 €	1.343 €	no disp	2.388 €	4233	376 €	376 €	3.281 €	2.741 €	no disp	6.786 €
4125	256 €	256 €	1.899 €	1.632 €	no disp	2.388 €	4234	469 €	469 €	4.342 €	3.592 €	no disp	6.786 €
4133	241 €	241 €	1.719 €	1.487 €	no disp	3.581 €	4235	560 €	560 €	5.402 €	4.443 €	no disp	6.786 €
4134	288 €	288 €	2.258 €	1.920 €	no disp	3.581 €	4243	469 €	469 €	4.342 €	3.592 €	no disp	9.048 €
4135	334 €	334 €	2.797 €	2.353 €	no disp	3.581 €	4244	591 €	591 €	5.755 €			

PS 500

Condensadores

Los condensadores están fabricados con una carrocería de chapa galvanizada y lacada en blanco o inoxidable bajo pedido.





La batería está realizada con tubo de cobre de \varnothing 8mm y aleta de aluminio con paso de aleta 2.1 mm.



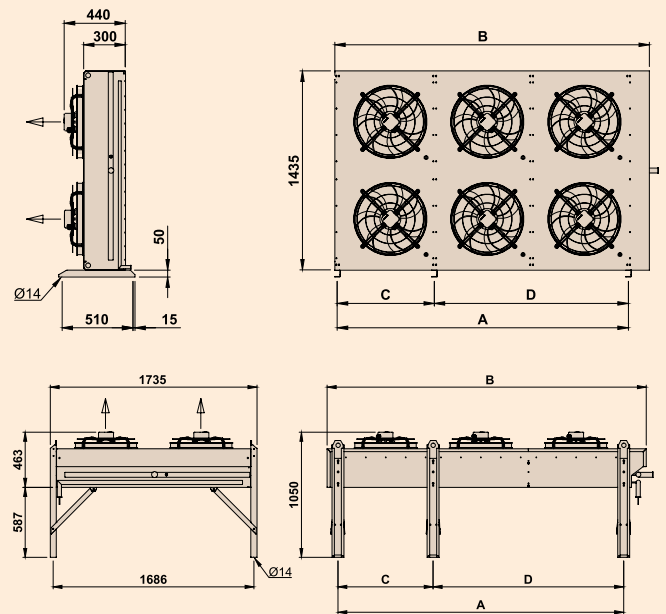
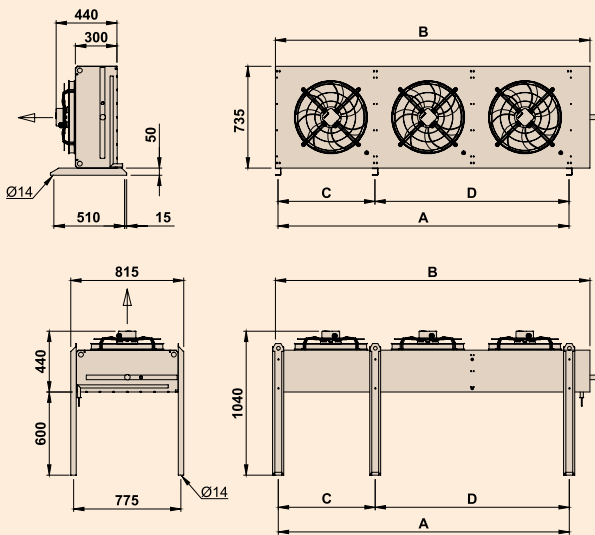

Los ventiladores son monofásicos para las series 350; 450 y trifásicos para la serie 500.



Dimensiones

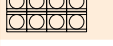

Modelo	Ventiladores	A	B	C	D
PS-L-LL5 11		700	870	-	-
PS-L-LL5 12		1400	1570	-	-
PS-L-LL5 13		2100	2270	-	-
PS-L-LL5 14		2800	2970	-	-
PS-L-LL5 15		3500	3670	1400	2100

Modelo	Ventiladores	A	B	C	D
PS-L-LL5 21		700	870	-	-
PS-L-LL5 22		1400	1570	-	-
PS-L-LL5 23		2100	2270	-	-
PS-L-LL5 24		2800	2970	-	-
PS-L-LL5 25		3500	3670	1400	2100

Datos y precios

Ø 500 mm

Modelo	Flujo Horiz.	Flujo Vert.	R449A	R134A	Caudal aire m ³ /h	Superf. m ²	Vol. interno dm ³	Nº Vent.	Abs. nominal A	Cons. nominal Kw	Nivel Sonoro		Peso Kg	IN Ø"	OUT Ø"
	P.V.P.	P.V.P.	Cap. Nominal ΔT=15K	Cap. Nominal ΔT=15K							10 m	5 m			
4 polos - Δ 1390 rpm															
PS5112	1.757 €	1.807 €	17,62	18,41	7.900	20,10	1,90	1	1,41	0,72	44	50	38	1-1/8	3/4
PS5113	1.873 €	1.923 €	23,05	24,09	7.300	30,20	2,80	1	1,41	0,72	44	50	41	1-3/8	7/8
PS5114	1.993 €	2.044 €	26,26	27,44	6.700	40,30	3,80	1	1,41	0,72	44	50	44	1-3/8	7/8
PS5115	2.096 €	2.146 €	27,86	29,11	6.100	50,30	4,70	1	1,41	0,72	44	50	47	1-3/8	7/8
PS5122	2.817 €	2.867 €	35,69	37,29	15.800	40,20	3,80	2	2,82	1,44	47	53	76	1-3/8	7/8
PS5123	3.007 €	3.057 €	46,64	48,73	14.600	60,40	5,60	2	2,82	1,44	47	53	82	1-3/8	1-1/8
PS5124	3.196 €	3.247 €	53,13	55,52	13.400	80,60	7,60	2	2,82	1,44	47	53	88	1-3/8	1-1/8
PS5125	3.416 €	3.466 €	56,16	58,68	12.200	100,60	9,40	2	2,82	1,44	47	53	94	1-5/8	1-1/8
PS5133	4.264 €	4.339 €	69,95	73,10	21.900	90,60	8,40	3	4,23	2,16	48	54	123	1-5/8	1-1/8
PS5134	4.541 €	4.616 €	79,66	83,24	20.100	120,90	11,40	3	4,23	2,16	48	54	132	1-5/8	1-3/8
PS5135	4.859 €	4.934 €	84,28	88,07	18.300	150,90	14,10	3	4,23	2,16	48	54	141	1-5/8	1-3/8
PS5143	5.598 €	5.699 €	93,27	97,46	29.200	120,80	11,20	4	5,64	2,88	50	56	164	1-5/8	1-3/8
PS5144	5.964 €	6.065 €	106,18	110,95	26.800	161,20	15,20	4	5,64	2,88	50	56	176	2-1/8	1-3/8
PS5145	6.389 €	6.489 €	112,41	117,46	24.400	201,20	18,80	4	5,64	2,88	50	56	188	2-1/8	1-3/8
PS5153	6.940 €	7.041 €	116,59	121,83	36.500	151,00	14,00	5	7,05	3,60	51	57	205	2-1/8	1-3/8
PS5154	7.399 €	7.500 €	132,70	138,66	33.500	201,50	19,00	5	7,05	2,45	51	57	220	2-1/8	1-3/8
PS5155	7.930 €	8.030 €	140,44	146,75	30.500	251,50	23,50	5	7,05	2,45	51	57	220	2-1/8	1-3/8
PS5223	5.953 €	6.029 €	93,27	97,46	29.200	120,80	11,20	4	5,64	2,88	50	56	164	2-1/8	1-3/8
PS5224	6.333 €	6.408 €	106,18	110,95	26.800	161,20	15,20	4	5,64	2,88	50	56	176	2-1/8	1-3/8
PS5225	6.735 €	6.811 €	112,41	117,46	24.400	201,20	18,80	4	5,64	2,88	50	56	188	2-1/8	1-3/8
PS5233	8.472 €	8.573 €	139,91	146,20	43.800	181,20	16,80	6	8,46	4,32	52	58	246	2-1/8	1-5/8
PS5234	9.024 €	9.124 €	159,31	166,47	40.200	241,80	22,80	6	8,46	4,32	52	58	264	2-1/8	1-5/8
PS5235	9.989 €	10.089 €	168,57	176,14	36.600	301,80	28,20	6	8,46	4,32	52	58	282	2-1/8	1-5/8
PS5243	11.132 €	11.232 €	186,54	194,93	58.400	241,60	22,40	8	11,28	5,76	54	60	328	2-5/8	1-5/8
PS5244	11.866 €	11.967 €	212,35	221,90	53.600	322,40	30,40	8	11,28	5,76	54	60	352	2-5/8	1-5/8
PS5245	12.718 €	12.818 €	224,73	234,83	48.800	402,40	37,60	8	11,28	5,76	54	60	376	2-5/8	1-5/8
PS5253	13.817 €	13.943 €	233,18	243,66	73.000	302,00	28,00	10	12,69	7,20	54	60	410	2-5/8	1-5/8
PS5254	14.739 €	14.864 €	265,49	277,42	67.000	403,00	38,00	10	14,10	7,20	54	60	440	3-1/8	2-1/8
PS5255	15.801 €	15.927 €	280,97	293,60	61.000	503,00	47,00	10	14,10	7,20	54	60	470	3-1/8	2-1/8
4 polos - Y 1180 rpm															
PS5112	1.757 €	1.807 €	13,26	13,86	6.600	20,10	1,90	1	0,95	0,55	39	45	38	1-1/8	3/4
PS5113	1.873 €	1.923 €	16,73	17,48	6.000	30,20	2,80	1	0,95	0,55	39	45	41	1-3/8	7/8
PS5114	1.993 €	2.044 €	12,55	13,11	3.150	40,30	3,80	1	0,86	0,19	39	45	37	1-1/8	3/4
PS5115	2.096 €	2.146 €	19,14	20,00	4.800	50,30	4,70	1	0,86	0,19	39	45	47	1-1/8	3/4
PS5122	2.817 €	2.867 €	26,70	27,90	13.200	40,20	3,80	2	1,90	1,10	42	48	76	1-1/8	3/4
PS5123	3.007 €	3.057 €	33,82	35,34	12.000	60,40	5,60	2	1,90	1,10	42	48	82	1-3/8	1-1/8
PS5124	3.196 €	3.247 €	37,56	39,25	10.800	80,60	7,60	2	1,90	1,10	42	48	88	1-3/8	1-1/8
PS5125	3.416 €	3.466 €	38,72	40,46	9.600	100,60	9,40	2	1,90	1,10	42	48	94	1-5/8	1-1/8
PS5133	4.264 €	4.339 €	50,82	53,10	18.000	90,60	8,40	3	2,85	1,65	43	49	123	1-5/8	1-1/8
PS5134	4.541 €	4.616 €	56,34	58,87	16.200	120,90	11,40	3	2,85	1,65	43	49	132	1-5/8	1-3/8
PS5135	4.859 €	4.934 €	58,03	60,64	14.400	150,90	14,10	3	2,85	1,65	43	49	141	1-5/8	1-3/8
PS5143	5.598 €	5.699 €	67,73	70,77	24.000	120,80	11,20	4	3,80	2,20	45	51	164	1-5/8	1-3/8
PS5144	5.964 €	6.065 €	75,12	78,49	21.600	161,20	15,20	4	3,80	2,20	45	51	176	2-1/8	1-3/8
PS5145	6.389 €	6.489 €	77,43	80,91	19.200	210,20	18,80	4	3,80	2,20	45	51	188	2-1/8	1-3/8
PS5153	6.940 €	7.041 €	84,64	88,44	30.000	151,00	14,00	5	4,75	2,75	46	52	205	2-1/8	1-3/8
PS5154	7.399 €	7.500 €	93,90	98,12	27.000	201,50	19,00	5	4,75	2,75	46	52	220	2-1/8	1-3/8
PS5155	7.930 €	8.030 €	96,74	101,09	24.000	251,50	23,50	5	4,75	2,75	46	52	235	2-1/8	1-3/8
PS5223	5.953 €	6.029 €	67,73	70,77	24.000	120,80	11,20	4	3,80	2,20	45	51	164	2-1/8	1-3/8
PS5224	6.333 €	6.408 €	75,12	78,49	21.600	161,20	15,20	4	3,80	2,20	45	51	176	2-1/8	1-3/8
PS5225	6.735 €	6.811 €	77,43	80,91	19.200	201,20	18,80	4	3,80	2,20	45	51	188	2-1/8	1-3/8
PS5233	8.472 €	8.573 €	101,55	106,11	36.000	181,20	16,80	6	5,70	3,30	47	53	246	2-1/8	1-5/8
PS5234	9.024 €	9.124 €	112,67	117,74	32.400	241,80	22,80	6	5,70	3,30	47	53	264	2-1/8	1-5/8
PS5235	9.989 €	10.089 €	116,15	121,37	28.800	301,80	28,20	6	5,70	3,30	47	53	282	2-1/8	1-5/8
PS5243	11.132 €	11.232 €	135,46	141,55	48.000	241,60	22,40	8	7,60	4,40	49	55	328	2-5/8	1-5/8
PS5244	11.866 €	11.967 €	150,23	156,98	43.200	322,40	30,40	8	7,60	1,52	49	55	352	2-5/8	1-5/8
PS5245	12.718 €	12.818 €	154,77	161,73	38.400	402,40	37,60	8	7,60	1,52	49	55	376	2-5/8	1-5/8
PS5253	13.817 €	13.943 €	169,28	176,89	60.000	302,00	28,00	10	9,50	5,50	49	55	410	2-5/8	1-5/8
PS5254	14.739 €	14.864 €	187,79	196,23	54.000	403,00	38,00	10	9,50	5,50	49	55	440	3-1/8	2-1/8
PS5255	15.801 €	15.927 €	230,33	240,68	48.000	503,00	47,00	10	9,50	5,50	49	55	470	3-1/8	2-1/8

Datos y precios

Ø 500 mm

Modelo	Flujo Horiz.	Flujo Vert.	Refrigerante		Caudal aire m³/h	Superf. m²	Vol. interno dm³	Nº Vent.	Abs. nominal A	Cons. nominal Kw	Nivel Sonoro		Peso Kg	IN Ø"	OUT Ø"
	P.V.P.	P.V.P.	Cap. Nominal ΔT=15K	Cap. Nominal ΔT=15K							10 m	5 m			
6 polos - Δ 930 rpm															
PSL5112	1.757 €	1.807 €	11,66	12,18	5.200	20,10	1,90	1	0,69	0,27	36	42	38	1-1/8	3/4
PSL5113	1.873 €	1.923 €	14,60	15,25	4.800	30,20	2,80	1	0,69	0,27	36	42	41	1-3/8	7/8
PSL5114	1.993 €	2.044 €	16,20	16,93	4.400	40,30	3,80	1	0,69	0,27	36	42	44	1-3/8	7/8
PSL5122	2.817 €	2.867 €	23,50	24,55	10.400	40,20	3,80	2	1,38	0,54	39	45	76	1-3/8	1-1/8
PSL5123	3.007 €	3.057 €	29,46	30,78	9.600	60,40	5,60	2	1,38	1,44	39	45	82	1-3/8	1-1/8
PSL5124	3.196 €	3.247 €	32,75	34,22	8.800	80,60	7,60	2	1,38	1,44	39	45	88	1-5/8	1-3/8
PSL5133	4.264 €	4.339 €	44,23	46,22	14.400	90,60	8,40	3	2,07	0,81	40	46	123	1-5/8	1-3/8
PSL5134	4.541 €	4.616 €	49,04	51,24	13.200	120,90	11,40	3	2,07	0,81	40	46	132	1-5/8	1-3/8
PSL5143	5.598 €	5.699 €	59,01	61,66	19.200	120,80	11,20	4	2,76	1,08	42	48	164	1-5/8	1-3/8
PSL5144	5.964 €	6.065 €	79,66	83,24	20.100	120,90	11,40	3	4,23	2,16	48	54	132	1-5/8	1-3/8
PSL5153	6.940 €	7.041 €	73,69	77,00	24.000	151,00	14,00	5	3,45	1,35	43	49	205	2-1/8	1-3/8
PSL5154	7.399 €	7.500 €	81,70	85,37	22.000	201,50	19,00	5	3,45	1,35	43	49	220	2-1/8	1-3/8
PSL5223	5.953 €	6.029 €	59,01	61,66	19.200	120,80	11,20	4	2,76	1,08	42	48	164	2-1/8	1-3/8
PSL5224	6.333 €	6.408 €	65,42	68,36	17.600	161,20	15,20	4	2,76	1,08	42	48	176	2-1/8	1-3/8
PSL5233	8.472 €	8.573 €	88,47	92,44	28.800	181,20	16,80	6	4,14	1,62	44	50	246	2-1/8	1-3/8
PSL5234	9.024 €	9.124 €	98,17	102,58	26.400	241,80	22,80	6	4,14	1,62	44	50	264	2-1/8	1-5/8
PSL5243	11.132 €	11.232 €	117,93	123,23	38.400	241,60	22,40	8	5,52	2,16	46	52	328	2-1/8	1-5/8
PSL5244	11.866 €	11.967 €	130,83	136,71	35.200	322,40	30,40	8	5,52	2,16	46	52	352	2-5/8	1-5/8
PSL5253	13.817 €	13.943 €	147,47	154,10	48.000	302,00	28,00	10	6,90	2,70	46	52	410	2-5/8	1-5/8
PSL5254	14.739 €	14.864 €	163,58	170,93	44.000	403,00	38,00	10	6,90	2,70	46	52	440	2-5/8	1-5/8
6 polos - Y 800 rpm															
PSL5112	1.757 €	1.807 €	10,50	10,97	4.400	20,10	1,90	1	0,40	0,19	31	37	38	1-1/8	3/4
PSL5113	1.873 €	1.923 €	12,82	13,39	4.000	30,20	2,80	1	0,40	0,19	31	37	41	1-3/8	7/8
PSL5114	1.993 €	2.044 €	13,88	14,51	3.600	40,30	3,80	1	0,40	0,19	31	37	44	1-3/8	7/8
PSL5122	2.817 €	2.867 €	21,18	22,13	8.800	40,20	3,80	2	0,80	0,38	34	40	76	1-3/8	1-1/8
PSL5123	3.007 €	3.057 €	25,81	26,97	8.000	60,40	5,60	2	0,80	0,38	34	40	82	1-3/8	1-1/8
PSL5124	3.196 €	3.247 €	28,12	29,39	7.200	80,60	7,60	2	0,80	0,38	34	40	88	1-5/8	1-3/8
PSL5133	4.264 €	4.339 €	38,72	40,46	12.000	90,60	8,40	3	1,20	0,57	35	41	123	1-5/8	1-3/8
PSL5134	4.541 €	4.616 €	42,19	44,08	10.800	120,90	11,40	3	1,20	0,57	35	41	132	1-5/8	1-3/8
PSL5143	5.598 €	5.699 €	51,62	53,94	16.000	120,80	11,20	4	1,60	0,76	37	43	164	1-5/8	1-3/8
PSL5144	5.964 €	6.065 €	56,25	58,78	14.400	161,20	15,20	4	1,60	0,76	37	43	176	2-1/8	1-3/8
PSL5153	6.940 €	7.041 €	64,53	67,43	20.000	151,00	14,00	5	2,00	0,95	38	44	205	2-1/8	1-3/8
PSL5154	7.399 €	7.500 €	70,22	73,38	18.000	201,50	19,00	5	2,00	0,95	38	44	220	2-1/8	1-3/8
PSL5223	5.953 €	6.029 €	51,62	53,94	16.000	120,80	11,20	4	1,60	0,76	37	43	164	2-1/8	1-3/8
PSL5224	6.333 €	6.408 €	56,34	58,87	14.400	161,20	15,20	4	1,60	0,76	37	43	176	2-1/8	1-3/8
PSL5233	8.472 €	8.573 €	77,43	80,91	24.000	181,20	16,80	6	2,40	1,14	39	45	246	2-1/8	1-3/8
PSL5234	9.024 €	9.124 €	84,28	88,07	21.600	241,80	22,80	6	2,40	1,14	39	45	264	2-1/8	1-5/8
PSL5243	11.132 €	11.232 €	103,24	107,88	32.000	241,60	22,40	8	3,20	1,52	41	47	328	2-1/8	1-5/8
PSL5244	11.866 €	11.967 €	112,41	117,46	28.800	322,40	30,40	8	3,20	1,52	41	47	352	2-5/8	1-5/8
PSL5253	13.817 €	13.943 €	128,96	134,76	40.000	302,00	28,00	10	4,00	1,90	41	47	410	2-5/8	1-5/8
PSL5254	14.739 €	14.864 €	140,53	146,85	36.000	403,00	38,00	10	4,00	1,90	41	47	440	2-5/8	1-5/8

Datos y precios

Ø 500 mm

Modelo	Flujo Horiz.	Flujo Vert.	R449A	R134A	Caudal aire m³/h	Superf. m²	Vol. interno dm³	Nº Vent.	Abs. nominal A	Cons. nominal Kw	Nivel Sonoro		Peso Kg	IN Ø"	OUT Ø"
	P.V.P.	P.V.P.	Cap. Nominal ΔT=15K	Cap. Nominal ΔT=15K							10 m	5 m			
6 polos - Δ 665 rpm															
PSLL5112	1.757 €	1.807 €	9,70	10,14	3.800	20,10	1,90	1	0,31	0,13	33	39	38	1-1/8	3/4
PSLL5113	1.873 €	1.923 €	11,66	12,18	3.400	30,20	2,80	1	0,31	0,13	33	39	41	1-3/8	7/8
PSLL5114	1.993 €	2.044 €	12,64	13,21	3.100	40,30	3,80	1	0,31	0,13	33	39	41	1-3/8	7/8
PSLL5122	2.817 €	2.867 €	19,58	20,46	7.600	40,20	3,80	2	0,62	0,26	36	42	76	1-3/8	1-1/8
PSLL5123	3.007 €	3.057 €	23,50	24,55	6.800	60,40	5,60	2	0,62	0,26	36	42	82	1-3/8	1-1/8
PSLL5124	3.196 €	3.247 €	25,54	26,69	6.200	80,60	7,60	2	0,62	0,26	36	42	88	1-5/8	1-3/8
PSLL5133	4.264 €	4.339 €	35,24	36,83	10.200	90,60	8,40	3	0,93	0,39	37	43	123	1-5/8	1-3/8
PSLL5134	4.541 €	4.616 €	38,36	40,08	9.300	120,90	11,40	3	0,93	0,39	37	43	132	1-5/8	1-3/8
PSLL5143	5.598 €	5.699 €	46,99	49,10	13.600	120,80	11,20	4	1,24	0,52	39	45	164	1-5/8	1-3/8
PSLL5144	5.964 €	6.065 €	51,18	53,48	12.400	161,20	15,20	4	1,24	0,52	39	45	176	2-1/8	1-3/8
PSLL5153	6.940 €	7.041 €	58,74	61,38	17.000	151,00	14,00	5	1,55	0,65	40	46	205	2-1/8	1-3/8
PSLL5154	7.399 €	7.500 €	63,90	66,77	15.500	201,50	19,00	5	1,55	0,65	40	46	220	2-1/8	1-3/8
PSLL5223	5.953 €	6.029 €	46,99	49,10	13.600	120,80	11,20	4	1,24	0,52	39	45	164	2-1/8	1-3/8
PSLL5224	6.333 €	6.408 €	51,18	53,48	12.400	161,20	15,20	4	1,24	0,52	39	45	176	2-1/8	1-3/8
PSLL5233	8.472 €	8.573 €	70,49	73,66	20.400	181,20	16,80	6	1,86	0,78	41	47	246	2-1/8	1-3/8
PSLL5234	9.024 €	9.124 €	76,72	80,17	18.600	241,80	22,80	6	1,86	0,78	41	47	264	2-1/8	1-5/8
PSLL5243	11.132 €	11.232 €	93,98	98,21	27.200	241,60	22,40	8	2,48	1,04	43	49	328	2-1/8	1-5/8
PSLL5244	11.866 €	11.967 €	102,26	106,86	24.800	322,40	30,40	8	2,48	1,04	43	49	352	2-5/8	1-5/8
PSLL5253	13.817 €	13.943 €	117,48	122,76	34.000	302,00	28,00	10	3,10	1,30	43	49	410	2-5/8	1-5/8
PSLL5254	14.739 €	14.864 €	127,89	133,64	31.000	403,00	38,00	10	3,10	1,30	43	49	440	2-5/8	1-5/8

6 polos - Y 525 rpm

PSLL5112	1.757 €	1.807 €	8,37	8,74	3.000	20,10	1,90	1	0,15	0,08	29	35	38	1-1/8	3/4
PSLL5113	1.873 €	1.923 €	9,70	10,14	2.600	30,20	2,80	1	0,15	0,08	29	35	41	1-3/8	7/8
PSLL5114	1.993 €	2.044 €	10,15	10,60	2.300	40,30	3,80	1	0,15	0,08	29	35	44	1-3/8	7/8
PSLL5122	2.817 €	2.867 €	16,82	17,58	6.000	40,20	3,80	2	0,30	0,16	32	38	76	1-3/8	1-1/8
PSLL5123	3.007 €	3.057 €	19,58	20,46	5.200	60,40	5,60	2	0,30	0,16	32	38	82	1-3/8	1-1/8
PSLL5124	3.196 €	3.247 €	20,47	21,39	4.600	80,60	7,60	2	0,30	0,16	32	38	88	1-5/8	1-3/8
PSLL5133	4.264 €	4.339 €	29,37	30,69	7.800	90,60	8,40	3	0,45	0,24	33	39	123	1-5/8	1-3/8
PSLL5134	4.541 €	4.616 €	30,79	32,18	6.900	120,90	11,40	3	0,45	0,24	33	39	132	1-5/8	1-3/8
PSLL5143	5.598 €	5.699 €	39,16	40,92	10.400	120,80	11,20	4	0,60	0,32	35	41	164	1-5/8	1-3/8
PSLL5144	5.964 €	6.065 €	41,03	42,87	9.200	161,20	15,20	4	0,60	0,32	35	41	176	2-1/8	1-3/8
PSLL5153	6.940 €	7.041 €	48,95	51,15	13.000	151,00	14,00	5	0,75	0,40	36	42	205	2-1/8	1-3/8
PSLL5154	7.399 €	7.500 €	51,26	53,57	11.500	201,50	19,00	5	0,75	0,40	36	42	220	2-1/8	1-3/8
PSLL5223	5.953 €	6.029 €	39,16	40,92	10.400	120,80	11,20	4	0,60	0,32	35	41	164	2-1/8	1-3/8
PSLL5224	6.333 €	6.408 €	41,03	42,87	9.200	161,20	15,20	4	0,60	0,32	35	41	176	2-1/8	1-3/8
PSLL5233	8.472 €	8.573 €	58,74	61,38	15.600	181,20	16,80	6	0,90	0,48	37	43	246	2-1/8	1-3/8
PSLL5234	9.024 €	9.124 €	61,50	64,26	13.800	241,80	22,80	6	0,90	0,48	37	43	264	2-1/8	1-5/8
PSLL5243	11.132 €	11.232 €	78,32	81,84	20.800	241,60	22,40	8	1,20	0,64	39	45	328	2-1/8	1-5/8
PSLL5244	11.866 €	11.967 €	81,97	85,65	18.400	322,40	30,40	8	1,20	2,75	39	45	352	2-5/8	1-5/8
PSLL5253	13.817 €	13.943 €	97,90	102,30	26.000	302,00	28,00	10	1,50	0,80	39	45	410	2-5/8	1-5/8
PSLL5254	14.739 €	14.864 €	102,53	107,14	23.000	403,00	38,00	10	1,50	0,80	39	45	440	2-5/8	1-5/8

Opcionales

Código	ALE PRE	ALE HYD	ALE CU	EVP FRS	CHA AISI304	VENT EC	Código	ALE PRE	ALE HYD	ALE CU	EVP FRS	CHA AISI304	VENT EC
5112	132 €	132 €	460 €	477 €	no disp	942 €	5154	412 €	412 €	3.697 €	3.075 €	no disp	4.712 €
5113	147 €	147 €	640 €	621 €	no disp	942 €	5155	490 €	490 €	4.595 €	3.796 €	no disp	4.712 €
5114	163 €	163 €	819 €	766 €	no disp	942 €	5223	284 €	284 €	2.220 €	1.890 €	no disp	3.770 €
5115	178 €	178 €	999 €	910 €	no disp	942 €	5224	346 €	346 €	2.928 €	2.458 €	no disp	3.770 €
5122	163 €	163 €	819 €	766 €	no disp	1.885 €	5225	407 €	407 €	3.634 €	3.025 €	no disp	3.770 €
5123	194 €	194 €	1.180 €	1.054 €	no disp	1.885 €	5233	376 €	376 €	3.281 €	2.741 €	no disp	5.655 €
5124	225 €	225 €	1.539 €	1.343 €	no disp	1.885 €	5234	469 €	469 €	4.342 €	3.592 €	no disp	5.655 €
5125	256 €	256 €	1.899 €	1.632 €	no disp	1.885 €	5235	560 €	560 €	5.402 €	4.443 €	no disp	5.655 €
5133	241 €	241 €	1.719 €	1.487 €	no disp	2.827 €	5243	469 €	469 €	4.342 €	3.592 €	no disp	7.540 €
5134	288 €	288 €	2.258 €	1.920 €	no disp	2.827 €	5244	591 €	591 €	5.755 €	4.727 €	no disp	7.540 €
5135	334 €	334 €	2.797 €	2.353 €	no disp	2.827 €	5245	714 €	714 €	7.169 €	5.861 €	no disp	7.540 €
5143	288 €	288 €	2.258 €	1.920 €	no disp	3.770 €	5253	560 €	560 €	5.402 €	4.443 €	no disp	9.425 €
5144	349 €	349 €	2.977 €	2.497 €	no disp	3.770 €	5254	714 €	714 €	7.169 €	5.861 €	no disp	9.425 €
5145	412 €	412 €	3.697 €	3.075 €	no disp	3.770 €	5255	866 €	866 €	8.936 €	7.279 €	no disp	9.425 €
5153	334 €	334 €	2.797 €	2.353 €	no disp	4.712 €							