

AS 500

Condensadores

Los condensadores están fabricados con una carrocería de chapa galvanizada y lacada en blanco o inoxidable bajo pedido.





La batería esta realizada con tubo de cobre de \varnothing 10mm y aleta de aluminio con paso de aleta 2.1 mm.



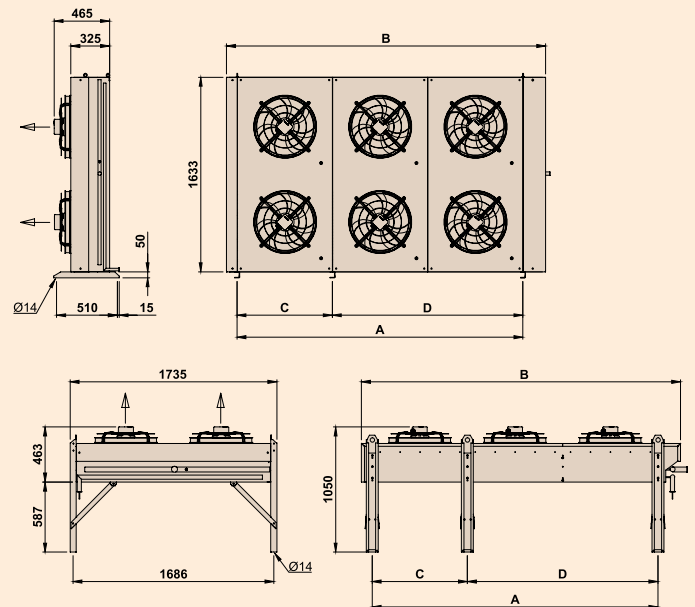
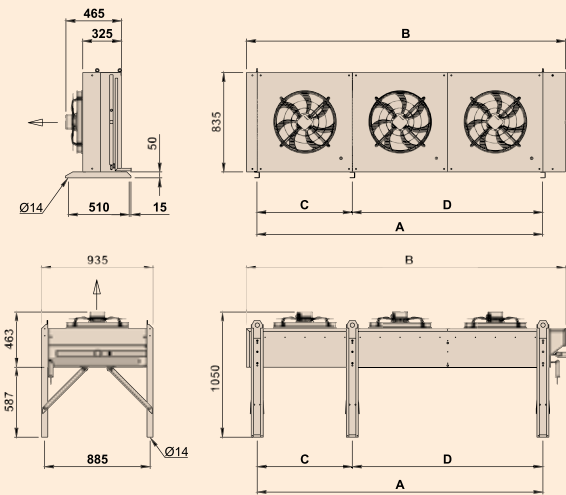

Los ventiladores son trifásicos para la serie 500.



Dimensiones



| Modelo | Ventiladores | A | B | C | D |
|-------------|---|------|------|------|------|
| AS-L-LL5 11 |  | 800 | 1080 | - | - |
| AS-L-LL5 12 |  | 1600 | 1880 | - | - |
| AS-L-LL5 13 |  | 2400 | 2680 | - | - |
| AS-L-LL5 14 |  | 3200 | 3480 | - | - |
| AS-L-LL5 15 |  | 4000 | 4280 | 1600 | 2400 |

| Modelo | Ventiladores | A | B | C | D |
|-------------|--|------|------|------|------|
| AS-L-LL5 21 |  | 800 | 1080 | - | - |
| AS-L-LL5 22 |  | 1600 | 1880 | - | - |
| AS-L-LL5 23 |  | 2400 | 2680 | - | - |
| AS-L-LL5 24 |  | 3200 | 3480 | - | - |
| AS-L-LL5 25 |  | 4000 | 4280 | 1600 | 2400 |

Datos y precios

Ø 500 mm

| Modelo | Flujo Horiz. | Flujo Vert. | R449A | R134A | Caudal aire m ³ /h | Superf. m ² | Vol. interno dm ³ | Nº Vent. | Abs. nominal A | Cons. nominal Kw | Nivel Sonoro | | Peso Kg | IN Ø" | OUT Ø" |
|----------------------|--------------|-------------|------------------------|------------------------|-------------------------------------|---------------------------|------------------------------------|----------|-------------------|---------------------|--------------|-----|------------|----------|-----------|
| | P.V.P. | P.V.P. | Cap. Nominal ΔT=15K | Cap. Nominal ΔT=15K | | | | | | | 10 m | 5 m | | | |
| 4 polos - Δ 1390 rpm | | | | | | | | | | | | | | | |
| AS5112 | 2.231 € | 2.282 € | 18,07 | 18,88 | 8.300 | 25,30 | 3,70 | 1 | 1,41 | 0,72 | 44 | 50 | 25 | 28 | 22 |
| AS5113 | 2.473 € | 2.523 € | 22,96 | 23,99 | 7.800 | 38,00 | 5,50 | 1 | 1,41 | 0,72 | 44 | 50 | 38 | 28 | 22 |
| AS5114 | 2.713 € | 2.764 € | 26,08 | 27,25 | 7.300 | 50,60 | 7,30 | 1 | 1,41 | 0,72 | 44 | 50 | 55 | 35 | 22 |
| AS5115 | 2.954 € | 3.004 € | 27,68 | 28,92 | 6.800 | 63,30 | 9,10 | 1 | 1,41 | 0,72 | 44 | 50 | 64 | 35 | 22 |
| AS5122 | 3.717 € | 3.767 € | 36,22 | 37,85 | 16.600 | 50,60 | 7,40 | 2 | 2,82 | 1,44 | 47 | 53 | 50 | 42 | 28 |
| AS5123 | 4.134 € | 4.185 € | 46,01 | 48,08 | 15.600 | 76,00 | 11,00 | 2 | 2,82 | 1,44 | 47 | 53 | 76 | 42 | 28 |
| AS5124 | 4.553 € | 4.603 € | 52,15 | 54,50 | 14.600 | 101,20 | 14,60 | 2 | 2,82 | 1,44 | 47 | 53 | 110 | 42 | 28 |
| AS5125 | 4.971 € | 5.022 € | 55,27 | 57,75 | 13.600 | 126,60 | 18,20 | 2 | 2,82 | 1,44 | 47 | 53 | 128 | 42 | 28 |
| AS5133 | 5.712 € | 5.787 € | 68,98 | 72,08 | 23.400 | 114,00 | 16,50 | 3 | 4,23 | 2,16 | 48 | 54 | 114 | 42 | 35 |
| AS5134 | 6.288 € | 6.363 € | 78,23 | 81,75 | 21.900 | 151,80 | 21,90 | 3 | 4,23 | 2,16 | 48 | 54 | 165 | 42 | 35 |
| AS5135 | 6.865 € | 6.940 € | 82,95 | 86,68 | 20.400 | 189,90 | 27,30 | 3 | 4,23 | 2,16 | 48 | 54 | 192 | 42 | 35 |
| AS5143 | 7.304 € | 7.404 € | 91,94 | 96,07 | 31.200 | 152,00 | 22,00 | 4 | 5,64 | 2,88 | 50 | 56 | 152 | 54 | 35 |
| AS5144 | 8.035 € | 8.135 € | 104,22 | 108,90 | 29.200 | 202,40 | 29,20 | 4 | 5,64 | 2,88 | 50 | 56 | 220 | 54 | 35 |
| AS5145 | 8.767 € | 8.867 € | 110,63 | 115,60 | 27.200 | 253,20 | 36,40 | 4 | 5,64 | 2,88 | 50 | 56 | 256 | 54 | 35 |
| AS5153 | 8.908 € | 9.009 € | 114,99 | 120,16 | 39.000 | 190,00 | 27,50 | 5 | 7,05 | 3,60 | 51 | 57 | 190 | 54 | 42 |
| AS5154 | 9.794 € | 9.895 € | 130,30 | 136,15 | 36.500 | 253,00 | 36,50 | 5 | 7,05 | 3,60 | 51 | 57 | 275 | 54 | 42 |
| AS5155 | 10.680 € | 10.780 € | 138,31 | 144,52 | 34.000 | 316,50 | 45,50 | 5 | 7,05 | 3,60 | 51 | 57 | 320 | 54 | 42 |
| AS5223 | 7.517 € | 7.593 € | 91,94 | 96,07 | 31.200 | 152,00 | 22,00 | 4 | 5,64 | 2,88 | 50 | 56 | 152 | 54 | 35 |
| AS5224 | 8.248 € | 8.324 € | 104,22 | 108,90 | 29.200 | 202,40 | 29,20 | 4 | 5,64 | 2,88 | 50 | 56 | 220 | 54 | 35 |
| AS5225 | 9.307 € | 9.382 € | 110,63 | 115,60 | 27.200 | 253,20 | 36,40 | 4 | 5,64 | 2,88 | 50 | 56 | 256 | 54 | 35 |
| AS5233 | 10.906 € | 11.007 € | 137,95 | 144,15 | 46.800 | 228,00 | 33,00 | 6 | 8,46 | 4,32 | 52 | 58 | 228 | 54 | 42 |
| AS5234 | 12.004 € | 12.105 € | 156,37 | 163,40 | 43.800 | 303,60 | 43,80 | 6 | 8,46 | 4,32 | 52 | 58 | 330 | 54 | 42 |
| AS5235 | 13.102 € | 13.203 € | 165,90 | 173,35 | 40.800 | 379,80 | 54,60 | 6 | 8,46 | 4,32 | 52 | 58 | 384 | 67 | 42 |
| AS5243 | 14.606 € | 14.707 € | 183,87 | 192,14 | 62.400 | 304,00 | 44,00 | 8 | 11,28 | 5,76 | 54 | 60 | 304 | 67 | 42 |
| AS5244 | 16.069 € | 16.170 € | 208,53 | 217,90 | 58.400 | 404,80 | 58,40 | 8 | 11,28 | 5,76 | 54 | 60 | 440 | 67 | 42 |
| AS5245 | 17.532 € | 17.632 € | 221,25 | 231,20 | 54.400 | 506,40 | 72,80 | 8 | 11,28 | 5,76 | 54 | 60 | 512 | 67 | 42 |
| AS5253 | 17.918 € | 18.044 € | 229,89 | 240,22 | 78.000 | 380,00 | 55,00 | 10 | 14,10 | 7,20 | 54 | 60 | 380 | 67 | 42 |
| AS5254 | 19.747 € | 19.872 € | 260,59 | 272,30 | 73.000 | 506,00 | 73,00 | 10 | 14,10 | 7,20 | 54 | 60 | 550 | 76 | 54 |
| AS5255 | 21.574 € | 21.700 € | 276,52 | 288,95 | 68.000 | 633,00 | 91,00 | 10 | 14,10 | 7,20 | 54 | 60 | 640 | 76 | 54 |
| 4 polos - Y 1180 rpm | | | | | | | | | | | | | | | |
| AS5112 | 2.231 € | 2.282 € | 16,29 | 17,02 | 7.000 | 25,30 | 3,70 | 1 | 0,95 | 0,55 | 41 | 47 | 25 | 28 | 22 |
| AS5113 | 2.473 € | 2.523 € | 20,29 | 21,20 | 6.500 | 38,00 | 5,50 | 1 | 0,95 | 0,55 | 41 | 47 | 38 | 28 | 22 |
| AS5114 | 2.713 € | 2.764 € | 22,78 | 23,81 | 6.000 | 50,60 | 7,30 | 1 | 0,95 | 0,55 | 41 | 47 | 55 | 35 | 22 |
| AS5115 | 2.954 € | 3.004 € | 23,59 | 24,65 | 5.500 | 63,30 | 9,10 | 1 | 0,95 | 0,55 | 41 | 47 | 64 | 35 | 22 |
| AS5122 | 3.717 € | 3.767 € | 32,57 | 34,04 | 14.000 | 50,60 | 7,40 | 2 | 1,90 | 1,10 | 44 | 50 | 50 | 42 | 28 |
| AS5123 | 4.134 € | 4.185 € | 40,50 | 42,32 | 13.000 | 76,00 | 11,00 | 2 | 1,90 | 1,10 | 44 | 50 | 76 | 42 | 28 |
| AS5124 | 4.553 € | 4.603 € | 45,57 | 47,62 | 12.000 | 101,20 | 14,60 | 2 | 1,90 | 1,10 | 44 | 50 | 110 | 42 | 28 |
| AS5125 | 4.971 € | 5.022 € | 47,08 | 49,20 | 11.000 | 126,60 | 18,20 | 2 | 1,90 | 1,10 | 44 | 50 | 128 | 42 | 28 |
| AS5133 | 5.712 € | 5.787 € | 60,79 | 63,52 | 19.500 | 114,00 | 16,50 | 3 | 2,85 | 1,65 | 45 | 51 | 114 | 42 | 35 |
| AS5134 | 6.288 € | 6.363 € | 68,26 | 71,33 | 18.000 | 151,80 | 21,90 | 3 | 2,85 | 1,65 | 45 | 51 | 165 | 42 | 35 |
| AS5135 | 6.865 € | 6.940 € | 70,67 | 73,84 | 16.500 | 189,90 | 27,30 | 3 | 2,85 | 1,65 | 45 | 51 | 192 | 42 | 35 |
| AS5143 | 7.304 € | 7.404 € | 80,99 | 84,63 | 26.000 | 152,00 | 22,00 | 4 | 3,80 | 2,20 | 47 | 53 | 152 | 54 | 35 |
| AS5144 | 8.035 € | 8.135 € | 91,05 | 95,14 | 24.000 | 202,40 | 29,20 | 4 | 3,80 | 2,20 | 47 | 53 | 220 | 54 | 35 |
| AS5145 | 8.767 € | 8.867 € | 94,25 | 98,49 | 22.000 | 253,20 | 36,40 | 4 | 3,80 | 2,20 | 47 | 53 | 256 | 54 | 35 |
| AS5153 | 8.908 € | 9.009 € | 101,28 | 105,83 | 32.500 | 190,00 | 27,50 | 5 | 4,75 | 2,75 | 48 | 54 | 190 | 54 | 42 |
| AS5154 | 9.794 € | 9.895 € | 113,83 | 118,95 | 30.000 | 253,00 | 36,50 | 5 | 4,75 | 2,75 | 48 | 54 | 275 | 54 | 42 |
| AS5155 | 10.680 € | 10.780 € | 117,84 | 123,13 | 27.500 | 316,50 | 45,50 | 5 | 4,75 | 2,75 | 48 | 54 | 320 | 54 | 42 |
| AS5223 | 7.517 € | 7.593 € | 80,99 | 84,63 | 26.000 | 152,00 | 22,00 | 4 | 3,80 | 2,20 | 47 | 53 | 152 | 54 | 35 |
| AS5224 | 8.248 € | 8.324 € | 91,05 | 95,14 | 24.000 | 202,40 | 29,20 | 4 | 3,80 | 2,20 | 47 | 53 | 220 | 54 | 35 |
| AS5225 | 9.307 € | 9.382 € | 94,25 | 98,49 | 22.000 | 253,20 | 36,40 | 4 | 3,80 | 2,20 | 47 | 53 | 256 | 54 | 35 |
| AS5233 | 10.906 € | 11.007 € | 121,57 | 127,04 | 39.000 | 228,00 | 33,00 | 6 | 5,70 | 3,30 | 49 | 55 | 228 | 54 | 42 |
| AS5234 | 12.004 € | 12.105 € | 136,62 | 142,76 | 36.000 | 303,60 | 43,80 | 6 | 5,70 | 3,30 | 49 | 55 | 330 | 54 | 42 |
| AS5235 | 13.102 € | 13.203 € | 141,33 | 147,68 | 33.000 | 379,80 | 54,60 | 6 | 5,70 | 3,30 | 49 | 55 | 384 | 67 | 42 |
| AS5243 | 14.606 € | 14.707 € | 162,07 | 169,35 | 52.000 | 304,00 | 44,00 | 8 | 7,60 | 4,40 | 51 | 57 | 304 | 67 | 42 |
| AS5244 | 16.069 € | 16.170 € | 182,09 | 190,28 | 48.000 | 404,80 | 58,40 | 8 | 7,60 | 4,40 | 51 | 57 | 440 | 67 | 42 |
| AS5245 | 17.532 € | 17.632 € | 188,50 | 196,97 | 44.000 | 506,40 | 72,80 | 8 | 7,60 | 4,40 | 51 | 57 | 512 | 67 | 42 |
| AS5253 | 17.918 € | 18.044 € | 202,56 | 211,67 | 65.000 | 380,00 | 55,00 | 10 | 9,50 | 5,50 | 51 | 57 | 380 | 67 | 42 |
| AS5254 | 19.747 € | 19.872 € | 227,66 | 237,89 | 60.000 | 506,00 | 73,00 | 10 | 9,50 | 5,50 | 51 | 57 | 550 | 76 | 54 |
| AS5255 | 21.574 € | 21.700 € | 235,58 | 246,17 | 55.000 | 633,00 | 91,00 | 10 | 9,50 | 5,50 | 51 | 57 | 640 | 76 | 54 |

Datos y precios
Ø 500 mm

| Modelo | Flujo Horiz. | Flujo Vert. | R449A | R134A | Caudal aire m ³ /h | Superf. m ² | Vol. interno dm ³ | Nº Vent. | Abs. nominal A | Cons. nominal Kw | Nivel Sonoro | | Peso Kg | IN Ø" | OUT Ø" |
|---------------------|--------------|-------------|------------------------|------------------------|-------------------------------------|---------------------------|------------------------------------|-------------|-------------------|------------------------|--------------|-----|------------|----------|-----------|
| | P.V.P. | P.V.P. | Cap. Nominal ΔT=15K | Cap. Nominal ΔT=15K | | | | | | | 10 m | 5 m | | | |
| 4 polos - Δ 930 rpm | | | | | | | | | | | | | | | |
| ASL5112 | 1.854 € | 1.905 € | 14,15 | 14,79 | 5.500 | 25,30 | 3,70 | 1 | 0,69 | 0,27 | 36 | 42 | 25 | 28 | 22 |
| ASL5113 | 2.096 € | 2.146 € | 17,27 | 18,04 | 5.100 | 38,00 | 5,50 | 1 | 0,69 | 0,27 | 36 | 42 | 38 | 28 | 22 |
| ASL5114 | 2.336 € | 2.387 € | 19,05 | 19,90 | 4.700 | 50,60 | 7,30 | 1 | 0,69 | 0,27 | 36 | 42 | 55 | 35 | 22 |
| ASL5122 | 3.177 € | 3.227 € | 28,21 | 29,48 | 11.000 | 50,60 | 7,40 | 2 | 1,38 | 0,54 | 39 | 45 | 50 | 35 | 22 |
| ASL5123 | 3.594 € | 3.644 € | 34,62 | 36,18 | 10.200 | 76,00 | 11,00 | 2 | 1,38 | 0,54 | 39 | 45 | 76 | 42 | 28 |
| ASL5124 | 4.013 € | 4.063 € | 38,00 | 39,71 | 9.400 | 101,20 | 14,60 | 2 | 1,38 | 0,54 | 39 | 45 | 110 | 42 | 28 |
| ASL5133 | 5.008 € | 5.083 € | 51,89 | 54,22 | 15.300 | 114,00 | 16,50 | 3 | 2,07 | 0,81 | 40 | 46 | 114 | 42 | 28 |
| ASL5134 | 5.584 € | 5.659 € | 57,05 | 59,61 | 14.100 | 151,80 | 21,90 | 3 | 2,07 | 0,81 | 40 | 46 | 165 | 42 | 28 |
| ASL5143 | 6.437 € | 6.537 € | 69,15 | 72,26 | 20.400 | 152,00 | 22,00 | 4 | 2,76 | 1,08 | 42 | 48 | 152 | 54 | 35 |
| ASL5144 | 7.168 € | 7.268 € | 76,01 | 79,42 | 18.800 | 202,40 | 29,20 | 4 | 2,76 | 1,08 | 42 | 48 | 220 | 54 | 35 |
| ASL5153 | 7.865 € | 7.966 € | 86,51 | 90,40 | 25.500 | 190,00 | 27,50 | 5 | 3,45 | 1,35 | 43 | 49 | 190 | 54 | 42 |
| ASL5154 | 8.751 € | 8.852 € | 95,05 | 99,32 | 23.500 | 253,00 | 36,50 | 5 | 3,45 | 1,35 | 43 | 49 | 275 | 54 | 42 |
| ASL5223 | 6.437 € | 6.512 € | 69,15 | 72,26 | 20.400 | 152,00 | 22,00 | 4 | 2,76 | 1,08 | 42 | 48 | 152 | 54 | 35 |
| ASL5224 | 7.168 € | 7.243 € | 76,01 | 79,42 | 18.800 | 202,40 | 29,20 | 4 | 2,76 | 1,08 | 42 | 48 | 220 | 54 | 35 |
| ASL5233 | 9.499 € | 9.599 € | 103,77 | 108,44 | 30.600 | 228,00 | 33,00 | 6 | 4,14 | 1,62 | 44 | 50 | 228 | 54 | 42 |
| ASL5234 | 10.597 € | 10.697 € | 114,01 | 119,13 | 28.200 | 303,60 | 43,80 | 6 | 4,14 | 1,62 | 44 | 50 | 330 | 54 | 42 |
| ASL5243 | 12.872 € | 12.973 € | 138,40 | 144,62 | 40.800 | 304,00 | 44,00 | 8 | 5,52 | 2,16 | 46 | 52 | 304 | 67 | 42 |
| ASL5244 | 14.335 € | 14.436 € | 152,01 | 158,84 | 37.600 | 404,80 | 58,40 | 8 | 5,52 | 2,16 | 46 | 52 | 440 | 67 | 42 |
| ASL5253 | 15.832 € | 15.958 € | 173,02 | 180,79 | 51.000 | 380,00 | 55,00 | 10 | 6,90 | 2,70 | 46 | 52 | 380 | 67 | 42 |
| ASL5254 | 17.661 € | 17.786 € | 190,10 | 198,65 | 47.000 | 506,00 | 73,00 | 10 | 6,90 | 2,70 | 46 | 52 | 550 | 76 | 54 |
| 4 polos - Y 800 rpm | | | | | | | | | | | | | | | |
| ASL5112 | 1.854 € | 1.905 € | 12,73 | 13,30 | 4.700 | 25,30 | 3,70 | 1 | 0,40 | 0,19 | 31 | 37 | 25 | 28 | 22 |
| ASL5113 | 2.096 € | 2.146 € | 15,58 | 16,28 | 4.400 | 38,00 | 5,50 | 1 | 0,40 | 0,19 | 31 | 37 | 38 | 28 | 22 |
| ASL5114 | 2.336 € | 2.387 € | 17,09 | 17,86 | 4.100 | 50,60 | 7,30 | 1 | 0,40 | 0,19 | 31 | 37 | 55 | 35 | 22 |
| ASL5122 | 3.177 € | 3.227 € | 25,45 | 26,60 | 9.400 | 50,60 | 7,40 | 2 | 0,80 | 0,38 | 34 | 40 | 50 | 35 | 22 |
| ASL5123 | 3.594 € | 3.644 € | 31,15 | 32,55 | 8.800 | 76,00 | 11,00 | 2 | 0,80 | 0,38 | 34 | 40 | 76 | 42 | 28 |
| ASL5124 | 4.013 € | 4.063 € | 34,18 | 35,71 | 8.200 | 101,20 | 14,60 | 2 | 0,80 | 0,38 | 34 | 40 | 110 | 42 | 28 |
| ASL5133 | 5.008 € | 5.083 € | 46,81 | 48,92 | 13.200 | 114,00 | 16,50 | 3 | 1,20 | 0,57 | 35 | 41 | 114 | 42 | 28 |
| ASL5134 | 5.584 € | 5.659 € | 51,18 | 53,48 | 12.300 | 151,80 | 21,90 | 3 | 1,20 | 0,57 | 35 | 41 | 165 | 42 | 28 |
| ASL5143 | 6.437 € | 6.537 € | 62,39 | 65,19 | 17.600 | 152,00 | 22,00 | 4 | 1,60 | 0,76 | 37 | 43 | 152 | 54 | 35 |
| ASL5144 | 7.168 € | 7.268 € | 68,26 | 71,33 | 16.400 | 202,40 | 29,20 | 4 | 1,60 | 0,76 | 37 | 43 | 220 | 54 | 35 |
| ASL5153 | 7.865 € | 7.966 € | 77,96 | 81,47 | 22.000 | 190,00 | 27,50 | 5 | 2,00 | 0,95 | 38 | 44 | 190 | 54 | 42 |
| ASL5154 | 8.751 € | 8.852 € | 85,35 | 89,19 | 20.500 | 253,00 | 36,50 | 5 | 2,00 | 0,95 | 38 | 44 | 275 | 54 | 42 |
| ASL5223 | 6.437 € | 6.512 € | 62,39 | 65,19 | 17.600 | 152,00 | 22,00 | 4 | 1,60 | 0,76 | 37 | 43 | 152 | 54 | 35 |
| ASL5224 | 7.168 € | 7.243 € | 68,26 | 71,33 | 16.400 | 202,40 | 29,20 | 4 | 1,60 | 0,76 | 37 | 43 | 220 | 54 | 35 |
| ASL5233 | 9.499 € | 9.599 € | 93,54 | 97,74 | 26.400 | 228,00 | 33,00 | 6 | 2,40 | 1,14 | 39 | 45 | 228 | 54 | 42 |
| ASL5234 | 10.597 € | 10.697 € | 102,44 | 107,04 | 24.600 | 303,60 | 43,80 | 6 | 2,40 | 1,14 | 39 | 45 | 330 | 54 | 42 |
| ASL5243 | 12.872 € | 12.973 € | 124,78 | 130,39 | 35.200 | 304,00 | 44,00 | 8 | 3,20 | 1,52 | 41 | 47 | 304 | 67 | 42 |
| ASL5244 | 14.335 € | 14.436 € | 136,62 | 142,76 | 32.800 | 404,80 | 58,40 | 8 | 3,20 | 1,52 | 41 | 47 | 440 | 67 | 42 |
| ASL5253 | 15.832 € | 15.958 € | 155,93 | 162,94 | 44.000 | 380,00 | 55,00 | 10 | 4,00 | 1,90 | 41 | 47 | 380 | 67 | 42 |
| ASL5254 | 17.661 € | 17.786 € | 170,70 | 178,37 | 41.000 | 506,00 | 73,00 | 10 | 4,00 | 1,90 | 41 | 47 | 550 | 76 | 54 |

Datos y precios

Ø 500 mm

| Modelo | Flujo Horiz. | Flujo Vert. | R449A | R134A | Caudal aire m³/h | Superf. m² | Vol. interno dm³ | Nº Vent. | Abs. nominal A | Cons. nominal Kw | Nivel Sonoro | | Peso Kg | IN Ø" | OUT Ø" |
|---------------------|--------------|-------------|------------------------|------------------------|---------------------|---------------|------------------------|----------|-------------------|---------------------|--------------|-----|------------|----------|-----------|
| | P.V.P. | P.V.P. | Cap. Nominal ΔT=15K | Cap. Nominal ΔT=15K | | | | | | | 10 m | 5 m | | | |
| 4 polos - Δ 665 rpm | | | | | | | | | | | | | | | |
| ASLL5112 | 2.231 € | 2.282 € | 11,39 | 11,90 | 4.000 | 25,30 | 3,70 | 1 | 0,31 | 0,13 | 36 | 42 | 25 | 28 | 22 |
| ASLL5113 | 2.473 € | 2.523 € | 13,35 | 13,95 | 3.500 | 38,00 | 5,50 | 1 | 0,31 | 0,13 | 36 | 42 | 38 | 28 | 22 |
| ASLL5114 | 2.713 € | 2.764 € | 14,15 | 14,79 | 3.200 | 50,60 | 7,30 | 1 | 0,31 | 0,13 | 36 | 42 | 55 | 35 | 22 |
| ASLL5122 | 3.717 € | 3.767 € | 22,78 | 23,81 | 8.000 | 50,60 | 7,40 | 2 | 0,62 | 0,26 | 39 | 45 | 50 | 35 | 22 |
| ASLL5123 | 4.134 € | 4.185 € | 26,61 | 27,81 | 7.000 | 76,00 | 11,00 | 2 | 0,62 | 0,26 | 39 | 45 | 76 | 42 | 28 |
| ASLL5124 | 4.553 € | 4.603 € | 28,21 | 29,48 | 6.400 | 101,20 | 14,60 | 2 | 0,62 | 0,26 | 39 | 45 | 110 | 42 | 28 |
| ASLL5133 | 5.712 € | 5.787 € | 39,96 | 41,76 | 10.500 | 114,00 | 16,50 | 3 | 0,93 | 0,39 | 40 | 46 | 114 | 42 | 28 |
| ASLL5134 | 6.288 € | 6.363 € | 42,36 | 44,27 | 9.600 | 151,80 | 21,90 | 3 | 0,93 | 0,39 | 40 | 46 | 165 | 42 | 28 |
| ASLL5143 | 7.304 € | 7.404 € | 53,22 | 55,61 | 14.000 | 152,00 | 22,00 | 4 | 1,24 | 0,52 | 42 | 48 | 152 | 54 | 35 |
| ASLL5144 | 8.035 € | 8.135 € | 56,43 | 58,96 | 12.800 | 202,40 | 29,20 | 4 | 1,24 | 0,52 | 42 | 48 | 220 | 54 | 35 |
| ASLL5153 | 8.908 € | 9.009 € | 66,57 | 69,56 | 17.500 | 190,00 | 27,50 | 5 | 1,55 | 0,65 | 43 | 49 | 190 | 54 | 42 |
| ASLL5154 | 9.794 € | 9.895 € | 70,58 | 73,75 | 16.000 | 253,00 | 36,50 | 5 | 1,55 | 0,65 | 43 | 49 | 275 | 54 | 42 |
| ASLL5223 | 7.517 € | 7.593 € | 53,22 | 55,61 | 14.000 | 152,00 | 22,00 | 4 | 1,24 | 0,52 | 42 | 48 | 152 | 54 | 35 |
| ASLL5224 | 8.248 € | 8.324 € | 56,43 | 58,96 | 12.800 | 202,40 | 29,20 | 4 | 1,24 | 0,52 | 42 | 48 | 220 | 54 | 35 |
| ASLL5233 | 10.906 € | 11.007 € | 79,92 | 83,51 | 21.000 | 228,00 | 33,00 | 6 | 1,86 | 0,78 | 44 | 50 | 228 | 54 | 42 |
| ASLL5234 | 12.004 € | 12.105 € | 84,64 | 88,44 | 19.200 | 303,60 | 43,80 | 6 | 1,86 | 0,78 | 44 | 50 | 330 | 54 | 42 |
| ASLL5243 | 14.606 € | 14.707 € | 106,53 | 111,32 | 28.000 | 304,00 | 44,00 | 8 | 2,48 | 1,04 | 46 | 52 | 304 | 67 | 42 |
| ASLL5244 | 16.069 € | 16.170 € | 112,94 | 118,02 | 25.600 | 404,80 | 58,40 | 8 | 2,48 | 1,04 | 46 | 52 | 440 | 67 | 42 |
| ASLL5253 | 17.918 € | 18.044 € | 133,14 | 139,13 | 35.000 | 380,00 | 55,00 | 10 | 3,10 | 1,30 | 46 | 52 | 380 | 67 | 42 |
| ASLL5254 | 19.747 € | 19.872 € | 141,15 | 147,50 | 32.000 | 506,00 | 73,00 | 10 | 3,10 | 1,30 | 46 | 52 | 550 | 76 | 54 |
| 4 polos - Y 525 rpm | | | | | | | | | | | | | | | |
| ASLL5112 | 2.231 € | 2.282 € | 9,88 | 10,32 | 3.250 | 25,30 | 3,70 | 1 | 0,15 | 0,08 | 31 | 37 | 25 | 28 | 22 |
| ASLL5113 | 2.473 € | 2.523 € | 11,84 | 12,37 | 3.000 | 38,00 | 5,50 | 1 | 0,15 | 0,08 | 31 | 37 | 38 | 28 | 22 |
| ASLL5114 | 2.713 € | 2.764 € | 12,55 | 13,11 | 2.750 | 50,60 | 7,30 | 1 | 0,15 | 0,08 | 31 | 37 | 55 | 35 | 22 |
| ASLL5122 | 3.717 € | 3.767 € | 19,85 | 20,74 | 6.500 | 50,60 | 7,40 | 2 | 0,30 | 0,16 | 34 | 40 | 50 | 35 | 22 |
| ASLL5123 | 4.134 € | 4.185 € | 23,67 | 24,74 | 6.000 | 76,00 | 11,00 | 2 | 0,30 | 0,16 | 34 | 40 | 76 | 42 | 28 |
| ASLL5124 | 4.553 € | 4.603 € | 25,01 | 26,13 | 5.500 | 101,20 | 14,60 | 2 | 0,30 | 0,16 | 34 | 40 | 110 | 42 | 28 |
| ASLL5133 | 5.712 € | 5.787 € | 35,51 | 37,11 | 9.000 | 114,00 | 16,50 | 3 | 0,45 | 0,24 | 35 | 41 | 114 | 42 | 28 |
| ASLL5134 | 6.288 € | 6.363 € | 37,56 | 39,25 | 8.250 | 151,80 | 21,90 | 3 | 0,45 | 0,24 | 35 | 41 | 165 | 42 | 28 |
| ASLL5143 | 7.304 € | 7.404 € | 47,35 | 49,48 | 12.000 | 152,00 | 22,00 | 4 | 0,60 | 0,32 | 37 | 43 | 152 | 54 | 35 |
| ASLL5144 | 8.035 € | 8.135 € | 50,11 | 52,36 | 11.000 | 202,40 | 29,20 | 4 | 0,60 | 0,32 | 37 | 43 | 220 | 54 | 35 |
| ASLL5153 | 8.908 € | 9.009 € | 59,19 | 61,85 | 15.000 | 190,00 | 27,50 | 5 | 0,75 | 0,40 | 38 | 44 | 190 | 54 | 42 |
| ASLL5154 | 9.794 € | 9.895 € | 62,57 | 65,38 | 13.750 | 253,00 | 36,50 | 5 | 0,75 | 0,40 | 38 | 44 | 275 | 54 | 42 |
| ASLL5223 | 7.517 € | 7.593 € | 47,35 | 49,48 | 12.000 | 152,00 | 22,00 | 4 | 0,60 | 0,32 | 37 | 43 | 152 | 54 | 35 |
| ASLL5233 | 10.906 € | 11.007 € | 71,02 | 74,21 | 18.000 | 228,00 | 33,00 | 6 | 0,90 | 0,48 | 39 | 45 | 228 | 54 | 42 |
| ASLL5234 | 12.004 € | 12.105 € | 75,12 | 78,49 | 16.500 | 303,60 | 43,80 | 6 | 0,90 | 0,48 | 39 | 45 | 330 | 54 | 42 |
| ASLL5243 | 14.606 € | 14.707 € | 94,70 | 98,95 | 24.000 | 304,00 | 44,00 | 8 | 1,20 | 0,64 | 41 | 47 | 304 | 67 | 42 |
| ASLL5244 | 16.069 € | 16.170 € | 100,13 | 104,63 | 22.000 | 404,80 | 58,40 | 8 | 1,20 | 0,64 | 41 | 47 | 440 | 67 | 42 |
| ASLL5253 | 17.918 € | 18.044 € | 118,37 | 123,69 | 30.000 | 380,00 | 55,00 | 10 | 1,50 | 0,80 | 41 | 47 | 380 | 67 | 42 |
| ASLL5254 | 19.747 € | 19.872 € | 125,22 | 130,85 | 27.500 | 506,00 | 73,00 | 10 | 1,50 | 0,80 | 41 | 47 | 550 | 76 | 54 |

Opcionales

| Código | ALE PRE | ALE HYD | ALE CU | EVP FR5 | CHA AISI304 | VENTEC | Código | ALE PRE | ALE HYD | ALE CU | EVP FR5 | CHA AISI304 | VENTEC |
|--------|---------|---------|---------|---------|-------------|---------|--------|---------|---------|----------|---------|-------------|---------|
| 5112 | 141 € | 141 € | 568 € | 564 € | no disp | 942 € | 5154 | 506 € | 506 € | 4.778 € | 3.942 € | no disp | 4.712 € |
| 5113 | 161 € | 161 € | 802 € | 752 € | no disp | 942 € | 5155 | 607 € | 607 € | 5.946 € | 4.880 € | no disp | 4.712 € |
| 5114 | 182 € | 182 € | 1.035 € | 939 € | no disp | 942 € | 5223 | 341 € | 341 € | 2.864 € | 2.406 € | no disp | 3.770 € |
| 5115 | 202 € | 202 € | 1.269 € | 1.127 € | no disp | 942 € | 5224 | 420 € | 420 € | 3.785 € | 3.146 € | no disp | 3.770 € |
| 5122 | 182 € | 182 € | 1.035 € | 939 € | no disp | 1.885 € | 5225 | 500 € | 500 € | 4.706 € | 3.885 € | no disp | 3.770 € |
| 5123 | 222 € | 222 € | 1.504 € | 1.315 € | no disp | 1.885 € | 5233 | 460 € | 460 € | 4.246 € | 3.515 € | no disp | 5.655 € |
| 5124 | 263 € | 263 € | 1.972 € | 1.690 € | no disp | 1.885 € | 5234 | 579 € | 579 € | 5.627 € | 4.624 € | no disp | 5.655 € |
| 5125 | 303 € | 303 € | 2.439 € | 2.065 € | no disp | 1.885 € | 5235 | 700 € | 700 € | 7.009 € | 5.733 € | no disp | 5.655 € |
| 5133 | 283 € | 283 € | 2.205 € | 1.878 € | no disp | 2.827 € | 5243 | 579 € | 579 € | 5.627 € | 4.624 € | no disp | 7.540 € |
| 5134 | 344 € | 344 € | 2.907 € | 2.441 € | no disp | 2.827 € | 5244 | 739 € | 739 € | 7.470 € | 6.103 € | no disp | 7.540 € |
| 5135 | 405 € | 405 € | 3.608 € | 3.004 € | no disp | 2.827 € | 5245 | 898 € | 898 € | 9.313 € | 7.582 € | no disp | 7.540 € |
| 5143 | 344 € | 344 € | 2.907 € | 2.441 € | no disp | 3.770 € | 5253 | 700 € | 700 € | 7.009 € | 5.733 € | no disp | 9.425 € |
| 5144 | 425 € | 425 € | 3.841 € | 3.191 € | no disp | 3.770 € | 5254 | 898 € | 898 € | 9.313 € | 7.582 € | no disp | 9.425 € |
| 5145 | 506 € | 506 € | 4.778 € | 3.942 € | no disp | 3.770 € | 5255 | 1.098 € | 1.098 € | 11.615 € | 9.430 € | no disp | 9.425 € |
| 5153 | 405 € | 405 € | 3.608 € | 3.004 € | no disp | 4.712 € | | | | | | | |

AS 630

Condensadores

Los condensadores están fabricados con una carrocería de chapa galvanizada y lacada en blanco o inoxidable bajo pedido.







La batería esta realizada con tubo de cobre de Ø 10mm y aleta de aluminio con paso de aleta 2.1 mm.

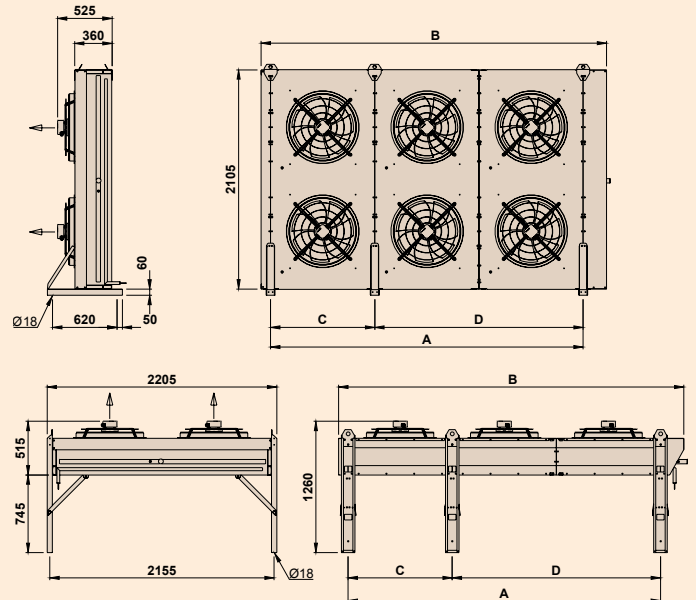
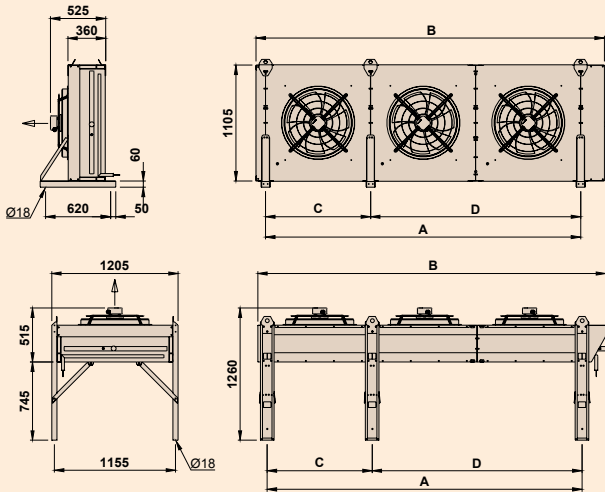





Los ventiladores son trifásicos para la serie 630.



Dimensiones



| Modelo | Ventiladores | A | B | C | D |
|-------------|---|------|------|------|------|
| AS-L-LL6 11 |  | 1000 | 1320 | - | - |
| AS-L-LL6 12 |  | 2000 | 2320 | - | - |
| AS-L-LL6 13 |  | 3000 | 3320 | - | - |
| AS-L-LL6 14 |  | 4000 | 4320 | - | - |
| AS-L-LL6 15 |  | 5000 | 5320 | 2000 | 3000 |
| AS-L-LL6 15 |  | 6000 | 6320 | 3000 | 3000 |

| Modelo | Ventiladores | A | B | C | D |
|-------------|--|------|------|------|------|
| AS-L-LL6 21 |  | 1000 | 1320 | - | - |
| AS-L-LL6 22 |  | 2000 | 2320 | - | - |
| AS-L-LL6 23 |  | 3000 | 3320 | - | - |
| AS-L-LL6 24 |  | 4000 | 4320 | - | - |
| AS-L-LL6 25 |  | 5000 | 5320 | 2000 | 3000 |
| AS-L-LL6 25 |  | 6000 | 6320 | 3000 | 3000 |

Datos y precios

Ø 630 mm

| Modelo | Flujo Horiz. | Flujo Vert. | Ø 630 mm | | Caudal aire m³/h | Superf. m² | Vol. interno dm³ | Nº Vent. | Abs. nominal A | Cons. nominal Kw | Nivel Sonoro | | Peso Kg | IN Ø" | OUT Ø" |
|----------------------|--------------|-------------|---------------------------------|---------------------------------|---------------------|---------------|------------------------|----------|-------------------|---------------------|--------------|-----|------------|----------|-----------|
| | P.V.P. | P.V.P. | R449A Cap. Nominal ΔT=15K | R134A Cap. Nominal ΔT=15K | | | | | | | 10 m | 5 m | | | |
| 4 polos - Δ 1330 rpm | | | | | | | | | | | | | | | |
| ASF6112 | 2.827 € | 2.978 € | 28,93 | 30,23 | 13.500 | 39,50 | 5,70 | 1 | 2,48 | 1,25 | 49 | 55 | 60 | 35 | 22 |
| ASF6113 | 3.100 € | 3.251 € | 37,56 | 39,25 | 13.000 | 59,30 | 8,60 | 1 | 2,48 | 1,25 | 49 | 55 | 65 | 35 | 28 |
| ASF6114 | 3.372 € | 3.523 € | 42,99 | 44,92 | 12.300 | 79,10 | 11,40 | 1 | 2,48 | 1,25 | 49 | 55 | 72 | 35 | 28 |
| ASF6115 | 3.646 € | 3.796 € | 46,81 | 48,92 | 11.800 | 98,90 | 14,30 | 1 | 2,48 | 1,25 | 49 | 55 | 79 | 35 | 28 |
| ASF6122 | 4.741 € | 4.967 € | 57,85 | 60,45 | 27.000 | 79,00 | 11,40 | 2 | 4,96 | 2,50 | 52 | 58 | 120 | 42 | 28 |
| ASF6123 | 5.212 € | 5.438 € | 75,21 | 78,59 | 26.000 | 118,60 | 17,20 | 2 | 4,96 | 2,50 | 52 | 58 | 130 | 42 | 35 |
| ASF6124 | 5.683 € | 5.909 € | 85,89 | 89,75 | 24.600 | 158,20 | 22,80 | 2 | 4,96 | 2,50 | 52 | 58 | 144 | 42 | 35 |
| ASF6125 | 6.155 € | 6.381 € | 93,63 | 97,84 | 23.600 | 197,80 | 28,60 | 2 | 4,96 | 2,50 | 52 | 58 | 158 | 42 | 35 |
| ASF6133 | 7.360 € | 7.662 € | 112,76 | 117,83 | 39.000 | 177,90 | 25,80 | 3 | 7,44 | 3,75 | 53 | 59 | 195 | 54 | 35 |
| ASF6134 | 8.032 € | 8.334 € | 128,87 | 134,66 | 36.900 | 237,30 | 34,20 | 3 | 7,44 | 3,75 | 53 | 59 | 216 | 54 | 35 |
| ASF6135 | 8.705 € | 9.006 € | 140,44 | 146,75 | 35.400 | 296,70 | 42,90 | 3 | 7,44 | 3,75 | 53 | 59 | 237 | 54 | 42 |
| ASF6143 | 9.425 € | 9.802 € | 150,41 | 157,17 | 52.000 | 237,20 | 34,40 | 4 | 9,92 | 5,00 | 55 | 61 | 260 | 54 | 42 |
| ASF6144 | 10.263 € | 10.640 € | 171,77 | 179,49 | 49.200 | 316,40 | 45,60 | 4 | 9,92 | 5,00 | 55 | 61 | 288 | 67 | 42 |
| ASF6145 | 11.101 € | 11.478 € | 186,90 | 195,30 | 47.200 | 395,60 | 57,20 | 4 | 9,92 | 5,00 | 55 | 61 | 316 | 67 | 42 |
| ASF6153 | 11.502 € | 11.954 € | 187,97 | 196,42 | 65.000 | 296,50 | 43,00 | 5 | 12,40 | 6,25 | 56 | 62 | 325 | 67 | 42 |
| ASF6154 | 12.504 € | 12.957 € | 214,76 | 224,41 | 61.500 | 395,50 | 57,00 | 5 | 12,40 | 6,25 | 56 | 62 | 360 | 67 | 42 |
| ASF6155 | 13.507 € | 13.960 € | 234,07 | 244,59 | 59.000 | 494,50 | 71,50 | 5 | 12,40 | 6,25 | 56 | 62 | 395 | 67 | 42 |
| ASF6164 | 15.720 € | 16.285 € | 257,66 | 269,24 | 73.800 | 474,60 | 68,40 | 6 | 14,88 | 7,50 | 57 | 63 | 410 | 76 | 54 |
| ASF6165 | 17.030 € | 17.595 € | 280,88 | 293,51 | 70.800 | 593,40 | 85,80 | 6 | 14,88 | 7,50 | 57 | 63 | 450 | 76 | 54 |
| ASF6223 | 9.689 € | 10.141 € | 150,41 | 157,17 | 52.000 | 237,20 | 34,40 | 4 | 9,92 | 5,00 | 55 | 61 | 260 | 54 | 42 |
| ASF6224 | 10.527 € | 10.979 € | 171,77 | 179,49 | 49.200 | 316,40 | 45,60 | 4 | 9,92 | 5,00 | 55 | 61 | 288 | 67 | 42 |
| ASF6225 | 11.365 € | 11.817 € | 187,26 | 195,67 | 47.200 | 395,60 | 57,20 | 4 | 9,92 | 5,00 | 55 | 61 | 316 | 67 | 42 |
| ASF6233 | 14.624 € | 15.190 € | 225,53 | 235,66 | 78.000 | 355,80 | 51,60 | 6 | 14,88 | 7,50 | 57 | 63 | 390 | 67 | 42 |
| ASF6234 | 15.933 € | 16.499 € | 257,66 | 269,24 | 73.800 | 474,60 | 68,40 | 6 | 14,88 | 7,50 | 57 | 63 | 432 | 67 | 42 |
| ASF6235 | 17.243 € | 17.809 € | 280,88 | 293,51 | 70.800 | 593,40 | 85,80 | 6 | 14,88 | 7,50 | 57 | 63 | 474 | 67 | 42 |
| ASF6243 | 18.849 € | 19.528 € | 300,38 | 313,88 | 104.000 | 474,40 | 68,80 | 8 | 19,84 | 10,00 | 59 | 65 | 520 | 76 | 54 |
| ASF6244 | 20.524 € | 21.203 € | 343,54 | 358,98 | 98.400 | 632,80 | 91,20 | 8 | 19,84 | 10,00 | 59 | 65 | 576 | 76 | 54 |
| ASF6245 | 22.199 € | 22.878 € | 374,60 | 391,44 | 94.400 | 791,20 | 114,40 | 8 | 19,84 | 10,00 | 59 | 65 | 632 | 76 | 54 |
| ASF6253 | 23.003 € | 23.795 € | 375,94 | 392,83 | 130.000 | 593,00 | 86,00 | 10 | 24,80 | 12,50 | 59 | 65 | 650 | 76 | 54 |
| ASF6254 | 25.010 € | 25.802 € | 429,51 | 448,82 | 123.000 | 791,00 | 114,00 | 10 | 24,80 | 12,50 | 59 | 65 | 720 | 76 | 54 |
| ASF6255 | 27.017 € | 27.809 € | 468,23 | 489,27 | 118.000 | 989,00 | 143,00 | 10 | 24,80 | 12,50 | 59 | 65 | 790 | 89 | 67 |
| ASF6264 | 31.439 € | 32.344 € | 515,40 | 538,56 | 147.600 | 949,20 | 136,80 | 12 | 29,76 | 15,00 | 60 | 66 | 740 | 89 | 67 |
| ASF6265 | 34.058 € | 34.963 € | 561,86 | 587,11 | 141.600 | 1.186,80 | 171,60 | 12 | 29,76 | 15,00 | 60 | 66 | 820 | 89 | 67 |
| 4 polos - Y 1070 rpm | | | | | | | | | | | | | | | |
| ASF6112 | 2.827 € | 2.978 € | 26,97 | 28,18 | 12.000 | 39,50 | 5,70 | 1 | 1,42 | 0,84 | 44 | 50 | 60 | 35 | 22 |
| ASF6113 | 3.100 € | 3.251 € | 33,91 | 35,43 | 11.400 | 59,30 | 8,60 | 1 | 1,42 | 0,84 | 44 | 50 | 65 | 35 | 28 |
| ASF6114 | 3.372 € | 3.523 € | 38,36 | 40,08 | 10.600 | 79,10 | 11,40 | 1 | 1,42 | 0,84 | 44 | 50 | 72 | 35 | 28 |
| ASF6115 | 3.646 € | 3.796 € | 41,12 | 42,97 | 10.000 | 98,90 | 14,30 | 1 | 1,42 | 0,84 | 44 | 50 | 79 | 35 | 28 |
| ASF6122 | 4.741 € | 4.967 € | 54,02 | 56,45 | 24.000 | 79,00 | 11,40 | 2 | 2,84 | 1,68 | 47 | 53 | 120 | 42 | 28 |
| ASF6123 | 5.212 € | 5.438 € | 67,91 | 70,96 | 22.800 | 118,60 | 17,20 | 2 | 2,84 | 1,68 | 47 | 53 | 130 | 42 | 35 |
| ASF6124 | 5.683 € | 5.909 € | 76,81 | 80,26 | 21.200 | 158,20 | 22,80 | 2 | 2,84 | 1,68 | 47 | 53 | 144 | 42 | 35 |
| ASF6125 | 6.155 € | 6.381 € | 82,24 | 85,93 | 20.000 | 197,80 | 28,60 | 2 | 2,84 | 1,68 | 47 | 53 | 158 | 42 | 35 |
| ASF6133 | 7.360 € | 7.662 € | 101,82 | 106,39 | 34.200 | 177,90 | 25,80 | 3 | 4,26 | 2,52 | 48 | 54 | 195 | 54 | 35 |
| ASF6134 | 8.032 € | 8.334 € | 115,17 | 120,34 | 31.800 | 237,30 | 34,20 | 3 | 4,26 | 2,52 | 48 | 54 | 216 | 54 | 35 |
| ASF6135 | 8.705 € | 9.006 € | 123,35 | 128,90 | 30.000 | 296,70 | 42,90 | 3 | 4,26 | 2,52 | 48 | 54 | 237 | 54 | 42 |
| ASF6143 | 9.425 € | 9.802 € | 135,81 | 141,92 | 45.600 | 237,20 | 34,40 | 4 | 5,68 | 3,36 | 50 | 56 | 260 | 54 | 42 |
| ASF6144 | 10.263 € | 10.640 € | 153,53 | 160,43 | 42.400 | 316,40 | 45,60 | 4 | 5,68 | 3,36 | 50 | 56 | 288 | 67 | 42 |
| ASF6145 | 11.101 € | 11.478 € | 164,47 | 171,86 | 40.000 | 395,60 | 57,20 | 4 | 5,68 | 3,36 | 50 | 56 | 316 | 67 | 42 |
| ASF6153 | 11.502 € | 11.954 € | 169,72 | 177,35 | 57.000 | 296,50 | 43,00 | 5 | 7,10 | 4,20 | 51 | 57 | 325 | 67 | 42 |
| ASF6154 | 12.504 € | 12.957 € | 191,97 | 200,60 | 53.000 | 395,50 | 57,00 | 5 | 7,10 | 4,20 | 51 | 57 | 360 | 67 | 42 |
| ASF6155 | 13.507 € | 13.960 € | 205,59 | 214,83 | 50.000 | 494,50 | 71,50 | 5 | 7,10 | 4,20 | 51 | 57 | 395 | 67 | 42 |
| ASF6164 | 15.720 € | 16.285 € | 230,33 | 240,68 | 63.600 | 474,60 | 68,40 | 6 | 8,52 | 5,04 | 52 | 58 | 432 | 76 | 54 |
| ASF6165 | 17.030 € | 17.595 € | 246,71 | 257,80 | 60.000 | 593,40 | 85,80 | 6 | 8,52 | 5,04 | 52 | 58 | 474 | 76 | 54 |
| ASF6223 | 9.689 € | 10.141 € | 135,81 | 141,92 | 45.600 | 237,20 | 34,40 | 4 | 5,68 | 3,36 | 50 | 56 | 260 | 54 | 42 |
| ASF6224 | 10.527 € | 10.979 € | 153,53 | 160,43 | 42.400 | 316,40 | 45,60 | 4 | 5,68 | 3,36 | 50 | 56 | 288 | 67 | 42 |
| ASF6225 | 11.365 € | 11.817 € | 164,47 | 171,86 | 40.000 | 395,60 | 57,20 | 4 | 5,68 | 3,36 | 50 | 56 | 316 | 67 | 42 |
| ASF6233 | 14.624 € | 15.190 € | 203,72 | 212,88 | 68.400 | 355,80 | 51,60 | 6 | 8,52 | 5,04 | 52 | 58 | 390 | 67 | 42 |
| ASF6234 | 15.933 € | 16.499 € | 230,33 | 240,68 | 63.600 | 474,60 | 68,40 | 6 | 8,52 | 5,04 | 52 | 58 | 432 | 67 | 42 |
| ASF6235 | 17.243 € | 17.809 € | 246,71 | 257,80 | 60.000 | 593,40 | 85,80 | 6 | 8,52 | 5,04 | 52 | 58 | 474 | 67 | 42 |
| ASF6243 | 18.849 € | 19.528 € | 271,63 | 283,84 | 91.200 | 474,40 | 68,80 | 8 | 11,36 | 6,72 | 54 | 60 | 520 | 76 | 54 |
| ASF6244 | 20.524 € | 21.203 € | 307,14 | 320,94 | 84.800 | 632,80 | 91,20 | 8 | 11,36 | 6,72 | 54 | 60 | 576 | 76 | 54 |
| ASF6245 | 22.199 € | 22.878 € | 329,03 | 343,82 | 80.000 | 791,20 | 114,40 | 8 | 11,36 | 6,72 | 54 | 60 | 632 | 76 | 54 |
| ASF6253 | 23.003 € | 23.795 € | 339,45 | 354,70 | 114.000 | 593,00 | 86,00 | 10 | 14,20 | 8,40 | 54 | 60 | 650 | 76 | 54 |
| ASF6254 | 25.010 € | 25.802 € | 383,95 | 401,20 | 106.000 | 791,00 | 114,00 | 10 | 14,20 | 8,40 | 54 | 60 | 720 | 76 | 54 |
| ASF6255 | 27.017 € | 27.809 € | 411,27 | 429,75 | 114.000 | 989,00 | 143,00 | 10 | 14,20 | 8,40 | 54 | 60 | 790 | 89 | 67 |
| ASF6264 | 31.439 € | 32.344 € | 460,66 | 481,37 | 127.200 | 949,20 | 136,80 | 12 | 17,04 | 10,08 | 55 | 61 | 740 | 89 | 67 |
| ASF6265 | 34.058 € | 34.963 € | 493,51 | 515,69 | 120.000 | 1.186,80 | 171,60 | 12 | 17,04 | 10,08 | 55 | 61 | 820 | 89 | 67 |

Datos y precios

Ø 630 mm

| Modelo | Flujo Horiz. | Flujo Vert. | R449A | R134A | Caudal aire m³/h | Superf. m² | Vol. interno dm³ | Nº Vent. | Abs. nominal A | Cons. nominal Kw | Nivel Sonoro | | Peso Kg | IN Ø" | OUT Ø" |
|---------------------|--------------|-------------|------------------------|------------------------|------------------------|---------------|------------------------|-------------|-------------------|------------------------|--------------|-----|------------|----------|-----------|
| | P.V.P. | P.V.P. | Cap. Nominal ΔT=15K | Cap. Nominal ΔT=15K | | | | | | | 10 m | 5 m | | | |
| 6 polos - Δ 890 rpm | | | | | | | | | | | | | | | |
| AS6112 | 2.827 € | 2.978 € | 24,30 | 25,39 | 9.600 | 39,50 | 5,70 | 1 | 1,20 | 0,40 | 39 | 45 | 60 | 35 | 22 |
| AS6113 | 3.100 € | 3.251 € | 29,99 | 31,34 | 9.000 | 59,30 | 8,60 | 1 | 1,20 | 0,40 | 39 | 45 | 65 | 35 | 28 |
| AS6114 | 3.372 € | 3.523 € | 34,09 | 35,62 | 8.600 | 79,10 | 11,40 | 1 | 1,20 | 0,40 | 39 | 45 | 72 | 35 | 28 |
| AS6115 | 3.646 € | 3.796 € | 36,05 | 37,67 | 8.100 | 98,90 | 14,30 | 1 | 1,20 | 0,40 | 39 | 45 | 79 | 35 | 28 |
| AS6122 | 4.741 € | 4.967 € | 48,51 | 50,69 | 19.200 | 79,00 | 11,40 | 2 | 2,40 | 0,80 | 42 | 48 | 120 | 42 | 28 |
| AS6123 | 5.212 € | 5.438 € | 59,99 | 62,68 | 18.000 | 118,60 | 17,20 | 2 | 2,40 | 0,80 | 42 | 48 | 130 | 42 | 35 |
| AS6124 | 5.683 € | 5.909 € | 68,09 | 71,15 | 17.200 | 158,20 | 22,80 | 2 | 2,40 | 0,80 | 42 | 48 | 144 | 42 | 35 |
| AS6125 | 6.155 € | 6.381 € | 72,09 | 75,33 | 16.200 | 197,80 | 28,60 | 2 | 2,40 | 0,80 | 42 | 48 | 158 | 42 | 35 |
| AS6133 | 7.360 € | 7.662 € | 89,98 | 94,02 | 27.000 | 177,90 | 25,80 | 3 | 3,60 | 1,20 | 43 | 49 | 195 | 54 | 35 |
| AS6134 | 8.032 € | 8.334 € | 102,17 | 106,76 | 25.800 | 237,30 | 34,20 | 3 | 3,60 | 1,20 | 43 | 49 | 216 | 54 | 35 |
| AS6135 | 8.705 € | 9.006 € | 108,14 | 113,00 | 24.300 | 296,70 | 42,90 | 3 | 3,60 | 1,20 | 43 | 49 | 237 | 54 | 42 |
| AS6143 | 9.425 € | 9.802 € | 119,88 | 125,27 | 36.000 | 237,20 | 34,40 | 4 | 4,80 | 1,60 | 45 | 51 | 260 | 54 | 42 |
| AS6144 | 10.263 € | 10.640 € | 136,26 | 142,38 | 34.400 | 316,40 | 45,60 | 4 | 4,80 | 1,60 | 45 | 51 | 288 | 67 | 42 |
| AS6145 | 11.101 € | 11.478 € | 144,18 | 150,66 | 32.400 | 395,60 | 57,20 | 4 | 4,80 | 1,60 | 45 | 51 | 316 | 67 | 42 |
| AS6153 | 11.502 € | 11.954 € | 149,88 | 156,61 | 45.000 | 296,50 | 43,00 | 5 | 6,00 | 2,00 | 46 | 52 | 325 | 67 | 42 |
| AS6154 | 12.504 € | 12.957 € | 170,35 | 178,00 | 43.000 | 395,50 | 57,00 | 5 | 6,00 | 2,00 | 46 | 52 | 360 | 67 | 42 |
| AS6155 | 13.507 € | 13.960 € | 180,23 | 188,33 | 40.500 | 494,50 | 71,50 | 5 | 6,00 | 2,40 | 46 | 52 | 395 | 67 | 42 |
| AS6164 | 15.493 € | 16.059 € | 204,34 | 213,53 | 51.600 | 474,60 | 68,40 | 6 | 7,20 | 2,40 | 47 | 53 | 432 | 76 | 54 |
| AS6165 | 16.804 € | 17.369 € | 216,27 | 225,99 | 48.600 | 593,40 | 85,80 | 6 | 7,20 | 2,40 | 47 | 53 | 474 | 76 | 54 |
| AS6223 | 9.689 € | 10.141 € | 119,88 | 125,27 | 36.000 | 237,20 | 34,40 | 4 | 4,80 | 1,60 | 45 | 51 | 260 | 54 | 42 |
| AS6224 | 10.527 € | 10.979 € | 136,26 | 142,38 | 34.400 | 316,40 | 45,60 | 4 | 4,80 | 1,60 | 45 | 51 | 288 | 67 | 42 |
| AS6225 | 11.365 € | 11.817 € | 144,18 | 150,66 | 32.400 | 395,60 | 57,20 | 4 | 4,80 | 1,60 | 45 | 51 | 316 | 67 | 42 |
| AS6233 | 14.222 € | 14.787 € | 179,87 | 187,95 | 54.000 | 355,80 | 51,60 | 6 | 7,20 | 2,40 | 47 | 53 | 390 | 67 | 42 |
| AS6234 | 15.933 € | 16.499 € | 204,34 | 213,53 | 51.600 | 474,60 | 68,40 | 6 | 7,20 | 2,40 | 47 | 53 | 432 | 67 | 42 |
| AS6235 | 16.877 € | 17.443 € | 216,27 | 225,99 | 48.600 | 593,40 | 85,80 | 6 | 7,20 | 2,40 | 47 | 53 | 474 | 67 | 42 |
| AS6243 | 18.849 € | 19.528 € | 239,86 | 250,64 | 72.000 | 474,40 | 68,80 | 8 | 9,60 | 3,20 | 49 | 55 | 520 | 76 | 54 |
| AS6244 | 20.524 € | 21.203 € | 272,52 | 284,77 | 68.800 | 632,80 | 91,20 | 8 | 9,60 | 3,20 | 49 | 55 | 576 | 76 | 54 |
| AS6245 | 22.199 € | 22.878 € | 288,36 | 301,32 | 64.800 | 791,20 | 114,40 | 8 | 9,60 | 3,20 | 49 | 55 | 632 | 76 | 54 |
| AS6253 | 23.003 € | 23.795 € | 299,84 | 313,32 | 90.000 | 593,00 | 86,00 | 10 | 12,00 | 4,00 | 49 | 55 | 650 | 76 | 54 |
| AS6254 | 25.010 € | 25.802 € | 340,60 | 355,91 | 86.000 | 791,00 | 114,00 | 10 | 12,00 | 4,00 | 49 | 55 | 600 | 76 | 54 |
| AS6255 | 27.017 € | 27.809 € | 360,45 | 376,65 | 81.000 | 989,00 | 143,00 | 10 | 12,00 | 4,00 | 49 | 55 | 650 | 89 | 67 |
| AS6264 | 31.439 € | 32.344 € | 408,78 | 427,15 | 103.200 | 949,20 | 136,80 | 12 | 14,40 | 4,80 | 50 | 56 | 864 | 89 | 67 |
| AS6265 | 34.058 € | 34.963 € | 432,54 | 451,98 | 97.200 | 1.186,80 | 171,60 | 12 | 14,40 | 4,80 | 50 | 56 | 948 | 89 | 67 |
| 6 polos - Y 690 rpm | | | | | | | | | | | | | | | |
| AS6112 | 2.827 € | 2.978 € | 20,74 | 21,67 | 7.600 | 39,50 | 5,70 | 1 | 0,68 | 0,40 | 33 | 39 | 60 | 35 | 22 |
| AS6113 | 3.100 € | 3.251 € | 25,28 | 26,41 | 7.000 | 59,30 | 8,60 | 1 | 0,68 | 0,40 | 33 | 39 | 65 | 35 | 28 |
| AS6114 | 3.372 € | 3.523 € | 28,39 | 29,67 | 6.800 | 79,10 | 11,40 | 1 | 0,68 | 0,40 | 33 | 39 | 72 | 35 | 28 |
| AS6115 | 3.646 € | 3.796 € | 29,90 | 31,25 | 6.400 | 98,90 | 14,30 | 1 | 0,68 | 0,40 | 33 | 39 | 79 | 35 | 28 |
| AS6122 | 4.741 € | 4.967 € | 41,56 | 43,43 | 15.200 | 79,00 | 11,40 | 2 | 1,36 | 0,80 | 36 | 42 | 120 | 42 | 28 |
| AS6123 | 5.212 € | 5.438 € | 50,64 | 52,92 | 14.000 | 118,60 | 17,20 | 2 | 1,36 | 0,80 | 36 | 42 | 130 | 42 | 35 |
| AS6124 | 5.683 € | 5.909 € | 56,69 | 59,24 | 13.600 | 158,20 | 22,80 | 2 | 1,36 | 0,80 | 36 | 42 | 144 | 42 | 35 |
| AS6125 | 6.155 € | 6.381 € | 59,72 | 62,40 | 12.800 | 197,80 | 28,60 | 2 | 1,36 | 0,80 | 36 | 42 | 158 | 42 | 35 |
| AS6133 | 7.360 € | 7.662 € | 75,92 | 79,33 | 21.000 | 177,90 | 25,80 | 3 | 2,04 | 1,20 | 37 | 43 | 195 | 54 | 35 |
| AS6134 | 8.032 € | 8.334 € | 85,08 | 88,91 | 20.400 | 237,30 | 34,20 | 3 | 2,04 | 1,20 | 37 | 43 | 216 | 54 | 35 |
| AS6135 | 8.705 € | 9.006 € | 89,62 | 93,65 | 19.200 | 296,70 | 42,90 | 3 | 2,04 | 1,20 | 37 | 43 | 237 | 54 | 42 |
| AS6143 | 9.425 € | 9.802 € | 101,28 | 105,83 | 28.000 | 237,20 | 34,40 | 4 | 2,72 | 1,60 | 39 | 45 | 260 | 54 | 42 |
| AS6144 | 10.263 € | 10.640 € | 113,39 | 118,48 | 27.200 | 316,40 | 45,60 | 4 | 2,72 | 1,60 | 39 | 45 | 288 | 67 | 42 |
| AS6145 | 11.101 € | 11.478 € | 119,44 | 124,81 | 25.600 | 395,60 | 57,20 | 4 | 2,72 | 1,60 | 39 | 45 | 316 | 67 | 42 |
| AS6153 | 11.502 € | 11.954 € | 126,56 | 132,25 | 35.000 | 296,50 | 43,00 | 5 | 3,40 | 2,00 | 40 | 46 | 325 | 67 | 42 |
| AS6154 | 12.504 € | 12.957 € | 141,78 | 148,15 | 34.000 | 395,50 | 57,00 | 5 | 3,40 | 2,00 | 40 | 46 | 360 | 67 | 42 |
| AS6155 | 13.507 € | 13.960 € | 149,34 | 156,05 | 32.000 | 494,50 | 71,50 | 5 | 3,40 | 2,00 | 40 | 46 | 395 | 67 | 42 |
| AS6164 | 15.493 € | 16.059 € | 170,08 | 177,72 | 40.800 | 474,60 | 68,40 | 6 | 4,08 | 2,40 | 41 | 47 | 432 | 76 | 54 |
| AS6165 | 16.804 € | 17.369 € | 179,16 | 187,21 | 38.400 | 593,40 | 85,80 | 6 | 4,08 | 2,40 | 41 | 47 | 474 | 76 | 54 |
| AS6223 | 9.689 € | 10.141 € | 101,28 | 105,83 | 28.000 | 237,20 | 34,40 | 4 | 2,72 | 1,60 | 39 | 45 | 260 | 54 | 42 |
| AS6224 | 10.527 € | 10.979 € | 113,39 | 118,48 | 27.200 | 316,40 | 45,60 | 4 | 2,72 | 1,60 | 39 | 45 | 288 | 67 | 42 |
| AS6225 | 11.365 € | 11.817 € | 119,44 | 124,81 | 25.600 | 395,60 | 57,20 | 4 | 2,72 | 1,60 | 39 | 45 | 316 | 67 | 42 |
| AS6233 | 14.222 € | 14.787 € | 151,92 | 158,75 | 42000,0 | 355,80 | 51,60 | 6 | 4,08 | 2,40 | 41 | 47 | 390 | 67 | 42 |
| AS6234 | 15.933 € | 16.499 € | 170,08 | 177,72 | 40.800 | 474,60 | 68,40 | 6 | 4,08 | 2,40 | 41 | 47 | 432 | 67 | 42 |
| AS6235 | 16.877 € | 17.443 € | 179,16 | 187,21 | 38.400 | 593,40 | 85,80 | 6 | 4,08 | 2,40 | 41 | 47 | 474 | 67 | 42 |
| AS6243 | 18.849 € | 19.528 € | 202,48 | 211,58 | 56.000 | 474,40 | 68,80 | 8 | 5,44 | 3,20 | 43 | 49 | 520 | 76 | 54 |
| AS6244 | 20.524 € | 21.203 € | 226,77 | 236,96 | 54.400 | 632,80 | 91,20 | 8 | 5,44 | 3,20 | 43 | 49 | 576 | 76 | 54 |
| AS6245 | 22.199 € | 22.878 € | 238,88 | 249,61 | 51.200 | 791,20 | 114,40 | 8 | 5,44 | 3,20 | 43 | 49 | 632 | 76 | 54 |
| AS6253 | 23.003 € | 23.795 € | 253,12 | 264,49 | 70.000 | 593,00 | 86,00 | 10 | 6,80 | 4,00 | 43 | 49 | 650 | 76 | 54 |
| AS6254 | 25.010 € | 25.802 € | 283,47 | 296,21 | 68.000 | 791,00 | 114,00 | 10 | 6,80 | 4,00 | 43 | 49 | 720 | 76 | 54 |
| AS6255 | 27.017 € | 27.809 € | 298,60 | 312,02 | 64.000 | 989,00 | 143,00 | 10 | 6,80 | 4,00 | 43 | 49 | 790 | 89 | 67 |
| AS6264 | 31.439 € | 32.344 € | 340,16 | 355,45 | 81.600 | 949,20 | 136,80 | 12 | 8,16 | 4,80 | 44 | 50 | 864 | 89 | 67 |
| AS6265 | 34.058 € | 34.963 € | 358,40 | 374,51 | 76.800 | 1.186,80 | 171,60 | 12 | 8,16 | 4,80 | 44 | 50 | 948 | 89 | 67 |

Datos y precios

Ø 630 mm

| Modelo | Flujo Horiz. | Flujo Vert. | R449A | R134A | Caudal aire m³/h | Superf. m² | Vol. interno dm³ | Nº Vent. | Abs. nominal A | Cons. nominal Kw | Nivel Sonoro | | Peso Kg | IN Ø" | OUT Ø" |
|---------------------|--------------|-------------|------------------------|------------------------|------------------------|---------------|------------------------|----------|-------------------|---------------------|--------------|-----|------------|----------|-----------|
| | P.V.P. | P.V.P. | Cap. Nominal ΔT=15K | Cap. Nominal ΔT=15K | | | | | | | 10 m | 5 m | | | |
| 8 polos - Y 520 rpm | | | | | | | | | | | | | | | |
| ASL6112 | 2.827 € | 2.978 € | 16,73 | 17,48 | 5.600 | 39,50 | 5,70 | 1 | 0,39 | 0,19 | 28 | 34 | 60 | 35 | 22 |
| ASL6113 | 3.100 € | 3.251 € | 19,85 | 20,74 | 5.100 | 59,30 | 8,60 | 1 | 0,39 | 0,19 | 28 | 34 | 65 | 35 | 28 |
| ASL6114 | 3.372 € | 3.523 € | 21,45 | 22,41 | 4.800 | 79,10 | 11,40 | 1 | 0,39 | 0,19 | 28 | 34 | 72 | 35 | 28 |
| ASL6122 | 4.741 € | 4.967 € | 33,46 | 34,97 | 11.200 | 79,00 | 11,40 | 2 | 0,78 | 0,38 | 31 | 37 | 120 | 42 | 28 |
| ASL6123 | 5.212 € | 5.438 € | 39,61 | 41,39 | 10.200 | 118,60 | 17,20 | 2 | 0,78 | 0,38 | 31 | 37 | 130 | 42 | 35 |
| ASL6124 | 5.683 € | 5.909 € | 42,81 | 44,73 | 9.600 | 158,20 | 22,80 | 2 | 0,78 | 0,38 | 31 | 37 | 144 | 42 | 35 |
| ASL6133 | 7.360 € | 7.662 € | 59,45 | 62,12 | 15.300 | 177,90 | 25,80 | 3 | 1,17 | 0,57 | 32 | 38 | 195 | 54 | 35 |
| ASL6134 | 8.032 € | 8.334 € | 64,26 | 67,15 | 14.400 | 237,30 | 34,20 | 3 | 1,17 | 0,57 | 32 | 38 | 216 | 54 | 35 |
| ASL6143 | 9.425 € | 9.802 € | 79,30 | 82,86 | 20.400 | 237,20 | 34,40 | 4 | 1,56 | 0,76 | 34 | 40 | 260 | 54 | 35 |
| ASL6144 | 10.263 € | 10.640 € | 85,71 | 89,56 | 19.200 | 316,40 | 45,60 | 4 | 1,56 | 0,76 | 34 | 40 | 288 | 54 | 35 |
| ASL6153 | 11.502 € | 11.954 € | 99,15 | 103,60 | 25.500 | 296,50 | 43,00 | 5 | 1,56 | 0,95 | 35 | 41 | 325 | 54 | 35 |
| ASL6154 | 12.504 € | 12.957 € | 107,07 | 111,88 | 24.000 | 395,50 | 57,00 | 5 | 1,56 | 0,95 | 35 | 41 | 360 | 54 | 35 |
| ASL6164 | 15.720 € | 16.285 € | 128,52 | 134,29 | 28.800 | 474,60 | 68,40 | 6 | 1,95 | 1,14 | 36 | 42 | 432 | 54 | 42 |
| ASL6223 | 9.689 € | 10.141 € | 79,30 | 82,86 | 20.400 | 237,20 | 34,40 | 4 | 1,56 | 0,76 | 34 | 40 | 260 | 54 | 35 |
| ASL6224 | 10.527 € | 10.979 € | 85,71 | 89,56 | 19.200 | 316,40 | 45,60 | 4 | 1,56 | 0,76 | 34 | 40 | 288 | 54 | 35 |
| ASL6233 | 14.624 € | 15.190 € | 118,90 | 124,25 | 30.600 | 355,80 | 51,60 | 6 | 1,95 | 1,14 | 36 | 42 | 390 | 54 | 42 |
| ASL6234 | 15.933 € | 16.499 € | 128,52 | 134,29 | 28.800 | 474,60 | 68,40 | 6 | 1,95 | 1,14 | 36 | 42 | 432 | 54 | 42 |
| ASL6243 | 18.849 € | 19.528 € | 158,60 | 165,73 | 40.800 | 474,40 | 68,80 | 8 | 3,12 | 1,52 | 38 | 44 | 520 | 67 | 42 |
| ASL6244 | 20.524 € | 21.203 € | 171,33 | 179,03 | 38.400 | 632,80 | 91,20 | 8 | 3,12 | 1,52 | 38 | 44 | 576 | 67 | 42 |
| ASL6253 | 23.003 € | 23.795 € | 198,20 | 207,11 | 51.000 | 593,00 | 86,00 | 10 | 3,90 | 1,90 | 38 | 44 | 650 | 67 | 42 |
| ASL6254 | 25.010 € | 25.802 € | 214,13 | 223,76 | 48.000 | 791,00 | 114,00 | 10 | 3,90 | 1,90 | 38 | 44 | 720 | 76 | 54 |
| ASL6264 | 31.439 € | 32.344 € | 257,03 | 268,58 | 57.600 | 949,20 | 136,80 | 12 | 4,68 | 2,28 | 39 | 45 | 864 | 76 | 54 |
| 8 polos - Y 520 rpm | | | | | | | | | | | | | | | |
| ASL6112 | 2.827 € | 2.978 € | 16,73 | 17,48 | 5.600 | 39,50 | 5,70 | 1 | 0,39 | 0,19 | 28 | 34 | 60 | 35 | 22 |
| ASL6113 | 3.100 € | 3.251 € | 19,85 | 20,74 | 5.100 | 59,30 | 8,60 | 1 | 0,39 | 0,19 | 28 | 34 | 65 | 35 | 28 |
| ASL6114 | 3.372 € | 3.523 € | 21,45 | 22,41 | 4.800 | 79,10 | 11,40 | 1 | 0,39 | 0,19 | 28 | 34 | 72 | 35 | 28 |
| ASL6122 | 4.741 € | 4.967 € | 33,46 | 34,97 | 11.200 | 79,00 | 11,40 | 2 | 0,78 | 0,38 | 31 | 37 | 120 | 42 | 28 |
| ASL6123 | 5.212 € | 5.438 € | 39,61 | 41,39 | 10.200 | 118,60 | 17,20 | 2 | 0,78 | 0,38 | 31 | 37 | 130 | 42 | 35 |
| ASL6124 | 5.683 € | 5.909 € | 42,81 | 44,73 | 9.600 | 158,20 | 22,80 | 2 | 0,78 | 0,38 | 31 | 37 | 144 | 42 | 35 |
| ASL6133 | 7.360 € | 7.662 € | 59,45 | 62,12 | 15.300 | 177,90 | 25,80 | 3 | 1,17 | 0,57 | 32 | 38 | 195 | 54 | 35 |
| ASL6134 | 8.032 € | 8.334 € | 64,26 | 67,15 | 14.400 | 237,30 | 34,20 | 3 | 1,17 | 0,57 | 32 | 38 | 216 | 54 | 35 |
| ASL6143 | 9.425 € | 9.802 € | 79,30 | 82,86 | 20.400 | 237,20 | 34,40 | 4 | 1,56 | 0,76 | 34 | 40 | 260 | 54 | 35 |
| ASL6144 | 10.263 € | 10.640 € | 85,71 | 89,56 | 19.200 | 316,40 | 45,60 | 4 | 1,56 | 0,76 | 34 | 40 | 288 | 54 | 35 |
| ASL6153 | 11.502 € | 11.954 € | 99,15 | 103,60 | 25.500 | 296,50 | 43,00 | 5 | 1,56 | 0,95 | 35 | 41 | 325 | 54 | 35 |
| ASL6154 | 12.504 € | 12.957 € | 107,07 | 111,88 | 24.000 | 395,50 | 57,00 | 5 | 1,56 | 0,95 | 35 | 41 | 360 | 54 | 35 |
| ASL6164 | 15.720 € | 16.285 € | 128,52 | 134,29 | 28.800 | 474,60 | 68,40 | 6 | 1,95 | 1,14 | 36 | 42 | 432 | 54 | 42 |
| ASL6223 | 9.689 € | 10.141 € | 79,30 | 82,86 | 20.400 | 237,20 | 34,40 | 4 | 1,56 | 0,76 | 34 | 40 | 260 | 54 | 35 |
| ASL6224 | 10.527 € | 10.979 € | 85,71 | 89,56 | 19.200 | 316,40 | 45,60 | 4 | 1,56 | 0,76 | 34 | 40 | 288 | 54 | 35 |
| ASL6233 | 14.624 € | 15.190 € | 118,90 | 124,25 | 30.600 | 355,80 | 51,60 | 6 | 1,95 | 1,14 | 36 | 42 | 390 | 54 | 42 |
| ASL6234 | 15.933 € | 16.499 € | 128,52 | 134,29 | 28.800 | 474,60 | 68,40 | 6 | 1,95 | 1,14 | 36 | 42 | 432 | 54 | 42 |
| ASL6243 | 18.849 € | 19.528 € | 158,60 | 165,73 | 40.800 | 474,40 | 68,80 | 8 | 3,12 | 1,52 | 38 | 44 | 520 | 67 | 42 |
| ASL6244 | 20.524 € | 21.203 € | 171,33 | 179,03 | 38.400 | 632,80 | 91,20 | 8 | 3,12 | 1,52 | 38 | 44 | 576 | 67 | 42 |
| ASL6253 | 23.003 € | 23.795 € | 198,20 | 207,11 | 51.000 | 593,00 | 86,00 | 10 | 3,90 | 1,90 | 38 | 44 | 650 | 67 | 42 |
| ASL6254 | 25.010 € | 25.802 € | 214,13 | 223,76 | 48.000 | 791,00 | 114,00 | 10 | 3,90 | 1,90 | 38 | 44 | 720 | 76 | 54 |
| ASL6264 | 31.439 € | 32.344 € | 257,03 | 268,58 | 57.600 | 949,20 | 136,80 | 12 | 4,68 | 2,28 | 39 | 45 | 864 | 76 | 54 |

Datos y precios
Ø 630 mm

| Modelo | Flujo Horiz. | Flujo Vert. | R449A | R134A | Caudal aire m ³ /h | Superf. m ² | Vol. interno dm ³ | Nº Vent. | Abs. nominal A | Cons. nominal Kw | Nivel Sonoro | | Peso Kg | IN Ø" | OUT Ø" |
|----------------------|-----------------|-----------------|---------------------|---------------------|-------------------------------|------------------------|------------------------------|----------|----------------|------------------|--------------|-----|---------|-------|--------|
| | P.V.P. | P.V.P. | Cap. Nominal ΔT=15K | Cap. Nominal ΔT=15K | | | | | | | 10 m | 5 m | | | |
| 12 polos - Δ 440 rpm | | | | | | | | | | | | | | | |
| ASLL6112 | 2.827 € | 2.978 € | 15,58 | 16,28 | 5.050 | 39,50 | 5,70 | 1 | 0,57 | 0,21 | 26 | 32 | 60 | 35 | 22 |
| ASLL6113 | 3.100 € | 3.251 € | 18,42 | 19,25 | 4.650 | 59,30 | 8,60 | 1 | 0,57 | 0,21 | 26 | 32 | 65 | 35 | 28 |
| ASLL6114 | 3.372 € | 3.523 € | 19,40 | 20,27 | 4.300 | 79,10 | 11,40 | 1 | 0,57 | 0,21 | 26 | 32 | 72 | 35 | 28 |
| ASLL6122 | 4.741 € | 4.967 € | 31,24 | 32,64 | 10.100 | 79,00 | 11,40 | 2 | 1,14 | 0,42 | 29 | 35 | 120 | 42 | 28 |
| ASLL6123 | 5.212 € | 5.438 € | 36,94 | 38,60 | 9.300 | 118,60 | 17,20 | 2 | 1,14 | 0,42 | 29 | 35 | 130 | 42 | 35 |
| ASLL6124 | 5.683 € | 5.909 € | 38,72 | 40,46 | 8.600 | 158,20 | 22,80 | 2 | 1,14 | 0,42 | 29 | 35 | 144 | 42 | 35 |
| ASLL6133 | 7.360 € | 7.662 € | 55,36 | 57,85 | 13.950 | 177,90 | 25,80 | 3 | 1,71 | 0,63 | 30 | 36 | 195 | 54 | 35 |
| ASLL6134 | 8.032 € | 8.334 € | 58,12 | 60,73 | 12.900 | 237,30 | 34,20 | 3 | 1,71 | 0,63 | 30 | 36 | 216 | 54 | 35 |
| ASLL6143 | 9.425 € | 9.802 € | 73,78 | 77,10 | 18.600 | 237,20 | 34,40 | 4 | 2,28 | 0,84 | 32 | 38 | 260 | 54 | 35 |
| ASLL6144 | 10.263 € | 10.640 € | 77,43 | 80,91 | 17.200 | 316,40 | 45,60 | 4 | 2,28 | 0,84 | 32 | 38 | 288 | 54 | 35 |
| ASLL6153 | 11.502 € | 11.954 € | 92,29 | 96,44 | 23.250 | 296,50 | 43,00 | 5 | 2,85 | 1,05 | 33 | 39 | 325 | 54 | 35 |
| ASLL6154 | 12.504 € | 12.957 € | 96,83 | 101,18 | 21.500 | 395,50 | 57,00 | 5 | 2,85 | 1,05 | 33 | 39 | 360 | 54 | 35 |
| ASLL6164 | 15.720 € | 16.285 € | 116,23 | 121,46 | 25.800 | 474,60 | 68,40 | 6 | 3,42 | 1,26 | 34 | 40 | 432 | 54 | 42 |
| ASLL6223 | 9.689 € | 10.141 € | 73,78 | 77,10 | 18.600 | 237,20 | 34,40 | 4 | 2,28 | 0,84 | 32 | 38 | 260 | 54 | 35 |
| ASLL6224 | 10.527 € | 10.979 € | 77,43 | 80,91 | 17.200 | 316,40 | 45,60 | 4 | 2,28 | 0,84 | 32 | 38 | 288 | 54 | 35 |
| ASLL6233 | 14.624 € | 15.190 € | 110,72 | 115,69 | 27.900 | 355,80 | 51,60 | 6 | 3,42 | 1,26 | 34 | 40 | 390 | 54 | 42 |
| ASLL6234 | 15.933 € | 16.499 € | 116,23 | 121,46 | 25.800 | 474,60 | 68,40 | 6 | 3,42 | 1,26 | 34 | 40 | 432 | 54 | 42 |
| ASLL6243 | 18.849 € | 19.528 € | 147,65 | 154,29 | 37.200 | 474,40 | 68,80 | 8 | 4,56 | 1,68 | 36 | 42 | 520 | 67 | 42 |
| ASLL6244 | 20.524 € | 21.203 € | 154,95 | 161,91 | 34.400 | 632,80 | 91,20 | 8 | 4,56 | 1,68 | 36 | 42 | 576 | 67 | 42 |
| ASLL6253 | 23.003 € | 23.795 € | 184,59 | 192,88 | 46.500 | 593,00 | 86,00 | 10 | 5,70 | 2,10 | 36 | 42 | 650 | 67 | 42 |
| ASLL6254 | 25.010 € | 25.802 € | 193,66 | 202,37 | 43.000 | 791,00 | 114,00 | 10 | 5,70 | 2,10 | 36 | 42 | 720 | 76 | 54 |
| ASLL6264 | 31.439 € | 32.344 € | 232,38 | 242,82 | 51.600 | 949,20 | 136,80 | 12 | 6,84 | 2,52 | 37 | 43 | 864 | 76 | 54 |
| 12 polos - Y370 rpm | | | | | | | | | | | | | | | |
| ASLL6112 | 2.827 € | 2.978 € | 13,80 | 14,42 | 4.200 | 39,50 | 5,70 | 1 | 0,21 | 0,10 | 19 | 25 | 60 | 35 | 22 |
| ASLL6113 | 3.100 € | 3.251 € | 15,75 | 16,46 | 3.900 | 59,30 | 8,60 | 1 | 0,21 | 0,10 | 19 | 25 | 65 | 35 | 28 |
| ASLL6114 | 3.372 € | 3.523 € | 16,55 | 17,30 | 3.600 | 79,10 | 11,40 | 1 | 0,21 | 0,10 | 19 | 25 | 72 | 35 | 28 |
| ASLL6122 | 4.741 € | 4.967 € | 27,59 | 28,83 | 8.400 | 79,00 | 11,40 | 2 | 0,42 | 0,20 | 22 | 28 | 120 | 42 | 28 |
| ASLL6123 | 5.212 € | 5.438 € | 31,42 | 32,83 | 7.800 | 118,60 | 17,20 | 2 | 0,42 | 0,20 | 22 | 28 | 130 | 42 | 35 |
| ASLL6124 | 5.683 € | 5.909 € | 33,02 | 34,50 | 7.200 | 158,20 | 22,80 | 2 | 0,42 | 0,20 | 22 | 28 | 144 | 42 | 35 |
| ASLL6133 | 7.360 € | 7.662 € | 47,17 | 49,29 | 11.700 | 177,90 | 25,80 | 3 | 0,63 | 0,30 | 23 | 29 | 195 | 54 | 35 |
| ASLL6134 | 8.032 € | 8.334 € | 49,57 | 51,80 | 10.800 | 237,30 | 34,20 | 3 | 0,63 | 0,30 | 23 | 29 | 216 | 54 | 35 |
| ASLL6143 | 9.425 € | 9.802 € | 62,92 | 65,75 | 15.600 | 237,20 | 34,40 | 4 | 0,84 | 0,40 | 25 | 31 | 260 | 54 | 35 |
| ASLL6144 | 10.263 € | 10.640 € | 66,04 | 69,01 | 14.400 | 316,40 | 45,60 | 4 | 0,84 | 0,40 | 25 | 31 | 288 | 54 | 35 |
| ASLL6153 | 11.502 € | 11.954 € | 78,59 | 82,12 | 19.500 | 296,50 | 43,00 | 5 | 1,05 | 0,50 | 26 | 32 | 325 | 54 | 35 |
| ASLL6154 | 12.504 € | 12.957 € | 82,59 | 86,30 | 18.000 | 395,50 | 57,00 | 5 | 1,05 | 0,50 | 26 | 32 | 360 | 54 | 35 |
| ASLL6164 | 15.720 € | 16.285 € | 99,15 | 103,60 | 21.600 | 474,60 | 68,40 | 6 | 1,26 | 0,60 | 27 | 33 | 432 | 54 | 42 |
| ASLL6223 | 9.689 € | 10.141 € | 62,92 | 65,75 | 15.600 | 237,20 | 34,40 | 4 | 0,84 | 0,40 | 25 | 31 | 260 | 54 | 35 |
| ASLL6224 | 10.527 € | 10.979 € | 66,04 | 69,01 | 14.400 | 316,40 | 45,60 | 4 | 0,84 | 0,40 | 25 | 31 | 288 | 54 | 35 |
| ASLL6233 | 14.624 € | 15.190 € | 94,34 | 98,58 | 23.400 | 355,80 | 51,60 | 6 | 1,26 | 0,60 | 27 | 33 | 390 | 54 | 42 |
| ASLL6234 | 15.933 € | 16.499 € | 99,15 | 103,60 | 21.600 | 474,60 | 68,40 | 6 | 1,26 | 0,60 | 27 | 33 | 432 | 54 | 42 |
| ASLL6243 | 18.849 € | 19.528 € | 125,76 | 131,41 | 31.200 | 474,40 | 68,80 | 8 | 1,68 | 0,80 | 29 | 35 | 520 | 67 | 42 |
| ASLL6244 | 20.524 € | 21.203 € | 132,17 | 138,11 | 28.800 | 632,80 | 91,20 | 8 | 1,68 | 0,80 | 29 | 35 | 576 | 67 | 42 |
| ASLL6253 | 23.003 € | 23.795 € | 157,17 | 164,24 | 39.000 | 593,00 | 86,00 | 10 | 2,10 | 1,00 | 29 | 35 | 650 | 67 | 42 |
| ASLL6254 | 25.010 € | 25.802 € | 165,18 | 172,61 | 36.000 | 791,00 | 114,00 | 10 | 2,10 | 1,00 | 29 | 35 | 720 | 76 | 54 |
| ASLL6264 | 31.439 € | 32.344 € | 198,20 | 207,11 | 43.200 | 949,20 | 136,80 | 12 | 2,52 | 1,20 | 30 | 36 | 864 | 76 | 54 |

Opcionales

| Código | ALE PRE | ALE HYD | ALE CU | EVP FRS | CHAAISI304 | VENTEC |
|--------|---------|---------|----------|----------|------------|----------|
| 6112 | 163 € | 163 € | 827 € | 771 € | no disp | 1.194 € |
| 6113 | 195 € | 195 € | 1.190 € | 1.063 € | no disp | 1.194 € |
| 6114 | 226 € | 226 € | 1.553 € | 1.354 € | no disp | 1.194 € |
| 6115 | 258 € | 258 € | 1.916 € | 1.646 € | no disp | 1.194 € |
| 6122 | 226 € | 226 € | 1.553 € | 1.354 € | no disp | 2.388 € |
| 6123 | 289 € | 289 € | 2.279 € | 1.937 € | no disp | 2.388 € |
| 6124 | 352 € | 352 € | 3.006 € | 2.520 € | no disp | 2.388 € |
| 6125 | 415 € | 415 € | 3.732 € | 3.103 € | no disp | 2.388 € |
| 6133 | 383 € | 383 € | 3.369 € | 2.812 € | no disp | 3.581 € |
| 6134 | 479 € | 479 € | 4.458 € | 3.686 € | no disp | 3.581 € |
| 6135 | 573 € | 573 € | 5.548 € | 4.560 € | no disp | 3.581 € |
| 6143 | 479 € | 479 € | 4.458 € | 3.686 € | no disp | 4.775 € |
| 6144 | 604 € | 604 € | 5.911 € | 4.852 € | no disp | 4.775 € |
| 6145 | 730 € | 730 € | 7.364 € | 6.018 € | no disp | 4.775 € |
| 6153 | 573 € | 573 € | 5.548 € | 4.560 € | no disp | 5.969 € |
| 6154 | 730 € | 730 € | 7.364 € | 6.018 € | no disp | 5.969 € |
| 6155 | 887 € | 887 € | 9.179 € | 7.475 € | no disp | 5.969 € |
| 6164 | 856 € | 856 € | 8.816 € | 7.184 € | no disp | 7.163 € |
| 6165 | 1.044 € | 1.044 € | 10.995 € | 8.932 € | no disp | 7.163 € |
| 6223 | 474 € | 474 € | 4.406 € | 3.643 € | no disp | 4.775 € |
| 6224 | 598 € | 598 € | 5.841 € | 4.795 € | no disp | 4.775 € |
| 6225 | 723 € | 723 € | 7.276 € | 5.947 € | no disp | 4.775 € |
| 6233 | 660 € | 660 € | 6.558 € | 5.371 € | no disp | 7.163 € |
| 6234 | 847 € | 847 € | 8.709 € | 7.098 € | no disp | 7.163 € |
| 6235 | 1.033 € | 1.033 € | 10.862 € | 8.826 € | no disp | 7.163 € |
| 6243 | 847 € | 847 € | 8.709 € | 7.098 € | no disp | 9.550 € |
| 6244 | 1.096 € | 1.096 € | 11.580 € | 9.401 € | no disp | 9.550 € |
| 6245 | 1.345 € | 1.345 € | 14.450 € | 11.705 € | no disp | 9.550 € |
| 6253 | 1.033 € | 1.033 € | 10.862 € | 8.826 € | no disp | 11.938 € |
| 6254 | 1.345 € | 1.345 € | 14.450 € | 11.705 € | no disp | 11.938 € |
| 6255 | 1.655 € | 1.655 | 18.037 € | 14.584 € | no disp | 11.938 € |
| 6264 | 1.593 € | 1.593 € | 17.320 € | 14.008 € | no disp | 14.325 € |
| 6265 | 1.967 € | 1.967 € | 21.625 € | 17.463 € | no disp | 14.325 € |

AS 800

Condensadores

Los condensadores están fabricados con una carrocería de chapa galvanizada y lacada en blanco o inoxidable bajo pedido.







La batería está realizada con tubo de cobre de \varnothing 10mm y aleta de aluminio con paso de aleta 2.1 mm.

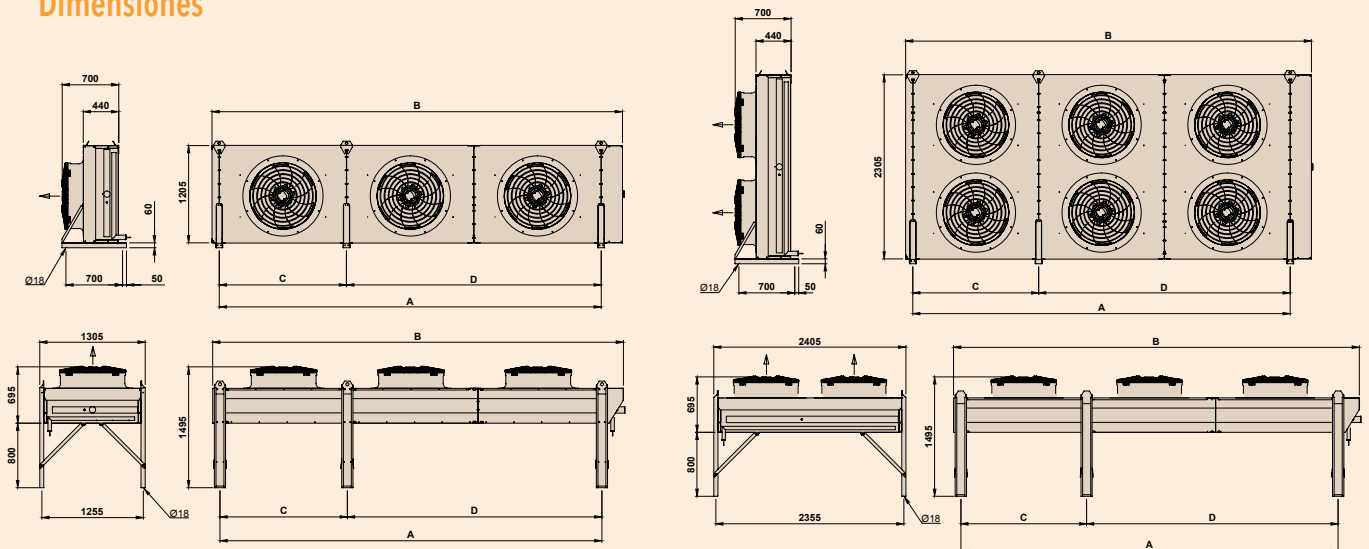





Los ventiladores son trifásicos para la serie 800.



Dimensiones



| Modelo | Ventiladores | A | B | C | D |
|-------------|---|------|------|------|------|
| AS-L-LL8 11 |  | 1575 | 1930 | - | - |
| AS-L-LL8 12 |  | 3150 | 3505 | - | - |
| AS-L-LL8 13 |  | 4725 | 5080 | - | - |
| AS-L-LL8 14 |  | 6300 | 6655 | 3150 | 3150 |
| AS-L-LL8 15 |  | 7875 | 8230 | 3150 | 4725 |
| AS-L-LL8 15 |  | 9450 | 9805 | 4725 | 4725 |

| Modelo | Ventiladores | A | B | C | D |
|-------------|---|------|------|------|------|
| AS-L-LL8 21 |  | 1575 | 1930 | - | - |
| AS-L-LL8 22 |  | 3150 | 3505 | - | - |
| AS-L-LL8 23 |  | 4725 | 5080 | - | - |
| AS-L-LL8 24 |  | 6300 | 6655 | 3150 | 3150 |
| AS-L-LL8 25 |  | 7875 | 8230 | 3150 | 4725 |
| AS-L-LL8 25 |  | 9450 | 9805 | 4725 | 4725 |

Datos y precios

Ø 800 mm

| Modelo | Flujo | | R449A | | R134A | | Caudal aire m³/h | Superf. m² | Vol. interno dm³ | Nº Vent. | Abs. nominal A | Cons. nominal Kw | Nivel Sonoro | | Peso Kg | IN Ø" | OUT Ø" |
|---------------------|------------------------|-----------------------|------------------------|------------------------|---------|----------|------------------------|---------------|------------------------|-------------|-------------------|------------------------|--------------|------|------------|----------|-----------|
| | Flujo Horiz. P.V.P. | Flujo Vert. P.V.P. | Cap. Nominal ΔT=15K | Cap. Nominal ΔT=15K | 10 m | 5 m | | | | | | | | | | | |
| 6 polos - Δ 880 rpm | | | | | | | | | | | | | | | | | |
| AS8113 | 5.339 € | 5.688 € | 63,10 | 65,94 | 21.000 | 109,20 | 15,80 | 1 | 3,90 | 1,93 | 48 | 54 | 140 | 42 | 28 | | |
| AS8114 | 5.831 € | 6.180 € | 72,54 | 75,80 | 20.000 | 145,60 | 21,00 | 1 | 3,90 | 1,93 | 48 | 54 | 156 | 42 | 35 | | |
| AS8115 | 6.322 € | 6.672 € | 78,05 | 81,56 | 19.000 | 182,00 | 26,30 | 1 | 3,90 | 1,93 | 48 | 54 | 170 | 42 | 35 | | |
| AS8123 | 9.123 € | 9.601 € | 126,20 | 131,87 | 42.000 | 218,40 | 31,60 | 2 | 7,80 | 3,86 | 51 | 57 | 280 | 54 | 42 | | |
| AS8124 | 10.092 € | 10.570 € | 145,16 | 151,68 | 40.000 | 291,20 | 42,00 | 2 | 7,80 | 3,86 | 51 | 57 | 312 | 54 | 42 | | |
| AS8125 | 11.061 € | 11.538 € | 156,11 | 163,12 | 38.000 | 364,00 | 52,60 | 2 | 7,80 | 3,86 | 51 | 57 | 340 | 54 | 42 | | |
| AS8133 | 12.978 € | 13.583 € | 189,30 | 197,81 | 63.000 | 327,60 | 47,40 | 3 | 11,70 | 5,79 | 52 | 58 | 420 | 67 | 42 | | |
| AS8134 | 14.381 € | 14.986 € | 217,69 | 227,48 | 60.000 | 436,80 | 63,00 | 3 | 11,70 | 5,79 | 52 | 58 | 468 | 67 | 42 | | |
| AS8135 | 15.786 € | 16.390 € | 234,07 | 244,59 | 57.000 | 546,00 | 78,90 | 3 | 11,70 | 5,79 | 52 | 58 | 510 | 67 | 42 | | |
| AS8143 | 16.670 € | 17.400 € | 252,40 | 263,75 | 84.000 | 436,80 | 63,20 | 4 | 15,60 | 7,72 | 54 | 60 | 560 | 76 | 54 | | |
| AS8144 | 18.512 € | 19.242 € | 290,23 | 303,27 | 80.000 | 582,40 | 84,00 | 4 | 15,60 | 7,72 | 54 | 60 | 624 | 76 | 54 | | |
| AS8145 | 20.355 € | 21.085 € | 312,12 | 326,15 | 76.000 | 728,00 | 105,20 | 4 | 15,60 | 7,72 | 54 | 60 | 680 | 76 | 54 | | |
| AS8153 | 20.228 € | 21.085 € | 315,59 | 329,78 | 105.000 | 546,00 | 79,00 | 5 | 19,50 | 9,65 | 55 | 61 | 700 | 76 | 54 | | |
| AS8154 | 22.558 € | 23.415 € | 362,85 | 379,16 | 100.000 | 728,00 | 105,00 | 5 | 19,50 | 9,65 | 55 | 61 | 780 | 76 | 54 | | |
| AS8155 | 24.889 € | 25.746 € | 390,18 | 407,71 | 95.000 | 910,00 | 131,50 | 5 | 19,50 | 9,65 | 55 | 61 | 850 | 76 | 54 | | |
| AS8163 | 23.789 € | 24.771 € | 378,70 | 395,72 | 126.000 | 655,20 | 94,80 | 6 | 23,40 | 11,58 | 56 | 62 | 840 | 76 | 54 | | |
| AS8164 | 26.606 € | 27.590 € | 435,39 | 454,96 | 120.000 | 873,60 | 126,00 | 6 | 23,40 | 11,58 | 56 | 62 | 936 | 76 | 54 | | |
| AS8165 | 29.424 € | 30.409 € | 468,23 | 489,27 | 114.000 | 1.092,00 | 157,80 | 6 | 23,40 | 11,58 | 56 | 62 | 1020 | 89 | 67 | | |
| AS8213 | 10.062 € | 10.578 € | 126,20 | 131,87 | 42.000 | 218,40 | 31,60 | 2 | 7,80 | 3,86 | 51 | 57 | 280 | 54 | 42 | | |
| AS8214 | 11.109 € | 11.624 € | 145,16 | 151,68 | 40.000 | 291,20 | 42,00 | 2 | 7,80 | 3,86 | 51 | 57 | 312 | 54 | 42 | | |
| AS8215 | 12.155 € | 12.671 € | 156,11 | 163,12 | 38.000 | 364,00 | 52,60 | 2 | 7,80 | 3,86 | 51 | 57 | 340 | 54 | 42 | | |
| AS8223 | 16.934 € | 17.664 € | 252,40 | 263,75 | 84.000 | 436,80 | 63,20 | 4 | 15,60 | 7,72 | 54 | 60 | 560 | 76 | 54 | | |
| AS8224 | 18.776 € | 19.506 € | 290,23 | 303,27 | 80.000 | 582,40 | 84,00 | 4 | 15,60 | 7,72 | 54 | 60 | 624 | 76 | 54 | | |
| AS8225 | 20.618 € | 21.349 € | 312,12 | 326,15 | 76.000 | 728,00 | 105,20 | 4 | 15,60 | 7,72 | 54 | 60 | 680 | 76 | 54 | | |
| AS8233 | 24.002 € | 24.985 € | 378,70 | 395,72 | 126.000 | 655,20 | 94,80 | 6 | 23,40 | 11,58 | 56 | 62 | 840 | 76 | 54 | | |
| AS8234 | 26.819 € | 27.803 € | 435,39 | 454,96 | 120.000 | 873,60 | 126,00 | 6 | 23,40 | 11,58 | 56 | 62 | 936 | 76 | 54 | | |
| AS8235 | 29.637 € | 30.623 € | 468,23 | 489,27 | 114.000 | 1.092,00 | 157,80 | 6 | 23,40 | 11,58 | 56 | 62 | 1020 | 89 | 67 | | |
| AS8243 | 33.340 € | 34.801 € | 504,90 | 527,59 | 168.000 | 873,60 | 126,40 | 8 | 31,20 | 15,44 | 57,5 | 63,5 | 1120 | 89 | 67 | | |
| AS8244 | 37.024 € | 38.484 € | 580,55 | 606,64 | 160.000 | 1.164,80 | 168,00 | 8 | 31,20 | 15,44 | 57,5 | 63,5 | 1248 | 89 | 67 | | |
| AS8245 | 40.707 € | 42.167 € | 624,25 | 652,30 | 152.000 | 1.456,00 | 210,40 | 8 | 31,20 | 15,44 | 57,5 | 63,5 | 1360 | 2x76 | 54 | | |
| AS8253 | 40.459 € | 42.172 € | 631,10 | 659,46 | 210.000 | 1.092,00 | 158,00 | 10 | 39,00 | 19,30 | 58 | 64 | 1400 | 2x76 | 54 | | |
| AS8254 | 45.118 € | 46.831 € | 725,71 | 758,32 | 200.000 | 1.456,00 | 210,00 | 10 | 39,00 | 19,30 | 58 | 64 | 1560 | 2x76 | 54 | | |
| AS8255 | 49.777 € | 51.490 € | 780,35 | 815,42 | 190.000 | 1.820,00 | 263,00 | 10 | 39,00 | 19,30 | 58 | 64 | 1700 | 2x76 | 54 | | |
| AS8263 | 47.576 € | 49.544 € | 757,30 | 791,34 | 252.000 | 1.310,40 | 189,60 | 12 | 46,80 | 23,16 | 59 | 65 | 1680 | 2x89 | 67 | | |
| AS8264 | 53.212 € | 55.179 € | 870,78 | 909,91 | 240.000 | 1.747,20 | 252,00 | 12 | 46,80 | 23,16 | 59 | 65 | 1872 | 2x89 | 67 | | |
| AS8265 | 58.848 € | 60.813 € | 936,46 | 978,55 | 228.000 | 2.184,00 | 315,60 | 12 | 46,80 | 23,16 | 59 | 65 | 2040 | 2x89 | 67 | | |
| 6 polos - Y 670 rpm | | | | | | | | | | | | | | | | | |
| AS8113 | 5.339 € | 5.688 € | 55,27 | 57,75 | 17.000 | 109,20 | 15,80 | 1 | 2,20 | 1,20 | 45 | 51 | 140 | 42 | 28 | | |
| AS8114 | 5.831 € | 6.180 € | 60,97 | 63,71 | 15.600 | 145,60 | 21,00 | 1 | 2,20 | 1,20 | 45 | 51 | 156 | 42 | 35 | | |
| AS8115 | 6.322 € | 6.672 € | 63,90 | 66,77 | 14.600 | 182,00 | 26,30 | 1 | 2,20 | 1,20 | 45 | 51 | 170 | 42 | 35 | | |
| AS8123 | 9.123 € | 9.601 € | 110,54 | 115,51 | 34.000 | 218,40 | 31,60 | 2 | 4,40 | 2,40 | 48 | 54 | 280 | 54 | 42 | | |
| AS8124 | 10.092 € | 10.570 € | 121,93 | 127,41 | 31.200 | 291,20 | 42,00 | 2 | 4,40 | 2,40 | 48 | 54 | 312 | 54 | 42 | | |
| AS8125 | 11.061 € | 11.538 € | 127,80 | 133,55 | 29.200 | 364,00 | 52,60 | 2 | 4,40 | 2,40 | 48 | 54 | 340 | 54 | 42 | | |
| AS8133 | 12.978 € | 13.583 € | 165,72 | 173,17 | 51.000 | 327,60 | 47,40 | 3 | 6,60 | 3,60 | 49 | 55 | 420 | 67 | 42 | | |
| AS8134 | 14.381 € | 14.986 € | 182,81 | 191,02 | 46.800 | 436,80 | 63,00 | 3 | 6,60 | 3,60 | 49 | 55 | 468 | 67 | 42 | | |
| AS8135 | 15.786 € | 16.390 € | 191,71 | 200,32 | 43.800 | 546,00 | 78,90 | 3 | 6,60 | 3,60 | 49 | 55 | 510 | 67 | 42 | | |
| AS8143 | 16.670 € | 17.400 € | 220,99 | 230,92 | 68.000 | 436,80 | 63,20 | 4 | 8,80 | 4,80 | 51 | 57 | 560 | 76 | 54 | | |
| AS8144 | 18.512 € | 19.242 € | 243,77 | 254,73 | 62.400 | 582,40 | 84,00 | 4 | 8,80 | 4,80 | 51 | 57 | 624 | 76 | 54 | | |
| AS8145 | 20.355 € | 21.085 € | 255,61 | 267,10 | 58.400 | 728,00 | 105,20 | 4 | 8,80 | 4,80 | 51 | 57 | 680 | 76 | 54 | | |
| AS8153 | 20.228 € | 21.085 € | 276,26 | 288,67 | 85.000 | 546,00 | 79,00 | 5 | 11,00 | 6,00 | 52 | 58 | 700 | 76 | 54 | | |
| AS8154 | 22.558 € | 23.415 € | 304,74 | 318,43 | 78.000 | 728,00 | 105,00 | 5 | 11,00 | 6,00 | 52 | 58 | 780 | 76 | 54 | | |
| AS8155 | 24.889 € | 25.746 € | 319,51 | 333,87 | 73.000 | 910,00 | 131,50 | 5 | 11,00 | 6,00 | 52 | 58 | 850 | 76 | 54 | | |
| AS8163 | 23.789 € | 24.771 € | 331,53 | 346,43 | 102.000 | 655,20 | 94,80 | 6 | 13,20 | 7,20 | 53 | 59 | 840 | 76 | 54 | | |
| AS8164 | 26.606 € | 27.590 € | 365,70 | 382,14 | 93.600 | 873,60 | 126,00 | 6 | 13,20 | 7,20 | 53 | 59 | 936 | 76 | 54 | | |
| AS8165 | 29.424 € | 30.409 € | 383,41 | 400,64 | 87.600 | 1.092,00 | 157,80 | 6 | 13,20 | 7,20 | 53 | 59 | 1020 | 89 | 67 | | |
| AS8213 | 10.062 € | 10.578 € | 110,54 | 115,51 | 34.000 | 218,40 | 31,60 | 2 | 4,40 | 2,40 | 48 | 54 | 280 | 54 | 42 | | |
| AS8214 | 11.109 € | 11.624 € | 121,93 | 127,41 | 31.200 | 291,20 | 42,00 | 2 | 4,40 | 2,40 | 48 | 54 | 312 | 54 | 42 | | |
| AS8215 | 12.155 € | 12.671 € | 127,80 | 133,55 | 29.200 | 364,00 | 52,60 | 2 | 4,40 | 2,40 | 48 | 54 | 340 | 54 | 42 | | |
| AS8223 | 16.934 € | 17.664 € | 220,99 | 230,92 | 68.000 | 436,80 | 63,20 | 4 | 8,80 | 4,80 | 51 | 57 | 560 | 76 | 54 | | |
| AS8224 | 18.776 € | 19.506 € | 243,77 | 254,73 | 62.400 | 582,40 | 84,00 | 4 | 8,80 | 4,80 | 51 | 57 | 624 | 76 | 54 | | |
| AS8225 | 20.618 € | 21.349 € | 243,77 | 254,73 | 58.400 | 728,00 | 105,20 | 4 | 8,80 | 4,80 | 51 | 57 | 680 | 76 | 54 | | |
| AS8233 | 24.002 € | 24.985 € | 331,53 | 346,43 | 102.000 | 655,20 | 94,80 | 6 | 13,20 | 7,20 | 53 | 59 | 840 | 76 | 54 | | |
| AS8234 | 26.819 € | 27.803 € | 365,70 | 382,14 | 93.600 | 873,60 | 126,00 | 6 | 13,20 | 7,20 | 53 | 59 | 936 | 76 | 54 | | |
| AS8235 | 29.637 € | 30.623 € | 383,41 | 400,64 | 87.600 | 1.092,00 | 157,80 | 6 | 13,20 | 7,20 | 53 | 59 | 1020 | 89 | 67 | | |
| AS8243 | 33.340 € | 34.801 € | 441,97 | 461,84 | 136.000 | 873,60 | 126,40 | 8 | 17,60 | 9,60 | 54,5 | 60,5 | 1120 | 89 | 67 | | |
| AS8244 | 37.024 € | 38.484 € | 487,54 | 509,45 | 124.800 | 1.164,80 | 168,00 | 8 | 17,60 | 9,60 | 54,5 | 60,5 | 1248 | 89 | 67 | | |
| AS8245 | 40.707 € | 42.167 € | 511,31 | 534,29 | 116.800 | 1.456,00 | 210,40 | 8 | 17,60 | 9,60 | 54,5 | 60,5 | 1360 | 2x76 | 54 | | |
| AS8253 | 40.459 € | 42.172 € | 552,51 | 577,34 | 170.000 | 1.092,00 | 158,00 | 10 | 22,00 | 12,00 | 55 | 61 | 1400 | 2x76 | 54 | | |
| AS8254 | 45.118 € | 46.831 € | 609,47 | 636,86 | 156.000 | 1.456,00 | 210,00 | 10 | 22,00 | 12,00 | 55 | 61 | 1560 | 2x76 | 54 | | |
| AS8255 | 49.777 € | 51.490 € | 639,11 | 667,83 | 146.000 | 1.820,00 | 263,00 | 10 | 22,00 | 12,00 | 55 | 61 | 1700 | 2x76 | 54 | | |
| AS8263 | 47.576 € | 49.544 € | 663,05 | 692,85 | 204.000 | 1.310,40 | 189,60 | 12 | 26,40 | 14,40 | 56 | 62 | 1680 | 2x89 | 67 | | |

Datos y precios
Ø 800 mm

| Modelo | Flujo Horiz. | Flujo Vert. | R449A | R134A | Caudal aire m³/h | Superf. m² | Vol. interno dm³ | Nº Vent. | Abs. nominal A | Cons. nominal Kw | Nivel Sonoro | | Peso Kg | IN Ø" | OUT Ø" |
|----------------------------|--------------|-------------|---------------------|---------------------|------------------|------------|------------------|----------|----------------|------------------|--------------|------|---------|-------|--------|
| | P.V.P. | P.V.P. | Cap. Nominal ΔT=15K | Cap. Nominal ΔT=15K | | | | | | | 10 m | 5 m | | | |
| 8 polos - Δ 660 rpm | | | | | | | | | | | | | | | |
| ASL8113 | 5.339 € | 5.688 € | 51,71 | 54,03 | 14.800 | 109,20 | 15,80 | 1 | 2,40 | 0,99 | 41 | 47 | 140 | 42 | 48 |
| ASL8114 | 5.831 € | 6.180 € | 54,82 | 57,29 | 13.800 | 145,60 | 21,00 | 1 | 2,40 | 0,99 | 41 | 47 | 156 | 42 | 48 |
| ASL8123 | 9.123 € | 9.601 € | 103,42 | 108,07 | 29.600 | 218,40 | 31,60 | 2 | 4,80 | 1,98 | 44 | 50 | 280 | 54 | 42 |
| ASL8124 | 10.092 € | 10.570 € | 109,56 | 114,48 | 27.600 | 291,20 | 42,00 | 2 | 4,80 | 1,98 | 44 | 50 | 312 | 54 | 42 |
| ASL8133 | 12.978 € | 13.583 € | 155,22 | 162,19 | 44.400 | 327,60 | 47,40 | 3 | 7,20 | 2,97 | 45 | 51 | 420 | 54 | 42 |
| ASL8134 | 14.381 € | 14.986 € | 164,38 | 171,77 | 41.400 | 436,80 | 63,00 | 3 | 7,20 | 2,97 | 45 | 51 | 468 | 67 | 42 |
| ASL8143 | 16.670 € | 17.400 € | 206,93 | 216,23 | 59.200 | 436,80 | 63,20 | 4 | 9,60 | 3,96 | 47 | 53 | 560 | 67 | 42 |
| ASL8144 | 18.512 € | 19.242 € | 219,12 | 228,97 | 55.200 | 582,40 | 84,00 | 4 | 9,60 | 3,96 | 47 | 53 | 624 | 67 | 42 |
| ASL8153 | 20.228 € | 21.085 € | 258,63 | 270,26 | 74.000 | 546,00 | 79,00 | 5 | 12,00 | 4,95 | 48 | 54 | 700 | 76 | 54 |
| ASL8154 | 22.558 € | 23.415 € | 273,94 | 286,25 | 69.000 | 728,00 | 105,00 | 5 | 12,00 | 4,95 | 48 | 54 | 780 | 76 | 54 |
| ASL8163 | 23.789 € | 24.771 € | 310,34 | 324,29 | 88.800 | 655,20 | 94,80 | 6 | 14,40 | 5,94 | 49 | 55 | 840 | 76 | 54 |
| ASL8164 | 26.606 € | 27.590 € | 328,68 | 343,45 | 82.800 | 873,60 | 126,00 | 6 | 14,40 | 5,94 | 49 | 55 | 936 | 76 | 54 |
| ASL8213 | 10.062 € | 10.578 € | 103,42 | 108,07 | 298.600 | 218,40 | 31,60 | 2 | 4,80 | 1,98 | 44 | 50 | 280 | 54 | 42 |
| ASL8214 | 11.109 € | 11.624 € | 109,56 | 114,48 | 27.600 | 291,20 | 42,00 | 2 | 4,80 | 1,98 | 44 | 50 | 312 | 54 | 42 |
| ASL8223 | 16.934 € | 17.664 € | 206,93 | 216,23 | 59.200 | 436,80 | 63,20 | 4 | 9,60 | 3,96 | 47 | 53 | 560 | 54 | 42 |
| ASL8224 | 18.776 € | 19.506 € | 219,12 | 228,97 | 55.200 | 582,40 | 84,00 | 4 | 9,60 | 3,96 | 47 | 53 | 624 | 76 | 54 |
| ASL8233 | 24.002 € | 24.985 € | 310,34 | 324,29 | 88.800 | 655,20 | 94,80 | 6 | 14,40 | 5,94 | 49 | 55 | 840 | 76 | 54 |
| ASL8234 | 26.819 € | 27.803 € | 328,68 | 343,45 | 82.800 | 873,60 | 126,00 | 6 | 14,40 | 5,94 | 49 | 55 | 936 | 76 | 54 |
| ASL8243 | 33.340 € | 34.801 € | 413,85 | 432,45 | 118.400 | 873,60 | 126,40 | 8 | 19,20 | 7,92 | 50,5 | 56,5 | 1120 | 89 | 67 |
| ASL8244 | 37.024 € | 38.484 € | 438,33 | 458,03 | 110.400 | 1.164,80 | 168,00 | 8 | 19,20 | 7,92 | 50,5 | 56,5 | 1248 | 89 | 67 |
| ASL8253 | 40.459 € | 42.172 € | 517,27 | 540,52 | 148.000 | 1.092,00 | 158,00 | 10 | 24,00 | 9,90 | 51 | 57 | 1400 | 89 | 67 |
| ASL8254 | 45.118 € | 46.831 € | 547,88 | 572,51 | 138.000 | 1.456,00 | 210,00 | 10 | 24,00 | 9,90 | 51 | 57 | 1560 | 2x76 | 54 |
| ASL8263 | 47.576 € | 49.544 € | 620,78 | 648,68 | 177.600 | 1.310,40 | 189,60 | 12 | 28,80 | 11,88 | 52 | 58 | 1680 | 2x76 | 54 |
| ASL8264 | 53.212 € | 55.179 € | 657,44 | 686,99 | 165.600 | 1.747,20 | 252,00 | 12 | 28,80 | 11,88 | 52 | 58 | 1872 | 2x89 | 67 |
| 8 polos - Y 580 rpm | | | | | | | | | | | | | | | |
| ASL8113 | 5.339 € | 5.688 € | 46,99 | 49,10 | 12.800 | 109,20 | 15,80 | 1 | 1,21 | 0,58 | 36 | 42 | 140 | 42 | 28 |
| ASL8114 | 5.831 € | 6.180 € | 49,40 | 51,62 | 11.800 | 145,60 | 21,00 | 1 | 1,21 | 0,58 | 36 | 42 | 156 | 42 | 28 |
| ASL8123 | 9.123 € | 9.601 € | 94,07 | 98,30 | 25.600 | 218,40 | 31,60 | 2 | 2,42 | 1,16 | 39 | 45 | 280 | 54 | 42 |
| ASL8124 | 10.092 € | 10.570 € | 98,79 | 103,23 | 23.600 | 291,20 | 42,00 | 2 | 2,42 | 1,16 | 39 | 45 | 312 | 54 | 42 |
| ASL8133 | 12.978 € | 13.583 € | 141,07 | 147,41 | 38.400 | 327,60 | 47,40 | 3 | 3,63 | 1,74 | 40 | 46 | 420 | 54 | 42 |
| ASL8134 | 14.381 € | 14.986 € | 148,10 | 154,75 | 35.400 | 436,80 | 63,00 | 3 | 3,63 | 1,74 | 40 | 46 | 468 | 67 | 42 |
| ASL8143 | 16.670 € | 17.400 € | 188,15 | 196,60 | 51.200 | 436,80 | 63,20 | 4 | 4,84 | 2,32 | 42 | 48 | 560 | 67 | 42 |
| ASL8144 | 18.512 € | 19.242 € | 197,49 | 206,37 | 47.200 | 582,40 | 84,00 | 4 | 4,84 | 2,32 | 42 | 48 | 624 | 67 | 42 |
| ASL8153 | 20.228 € | 21.085 € | 235,14 | 245,71 | 64.000 | 546,00 | 79,00 | 5 | 6,05 | 2,90 | 43 | 49 | 700 | 76 | 54 |
| ASL8154 | 22.558 € | 23.415 € | 246,89 | 257,98 | 59.000 | 728,00 | 105,00 | 5 | 6,05 | 2,90 | 43 | 49 | 780 | 76 | 54 |
| ASL8163 | 23.789 € | 24.771 € | 282,13 | 294,81 | 76.800 | 655,20 | 94,80 | 6 | 7,26 | 3,48 | 44 | 50 | 840 | 76 | 54 |
| ASL8164 | 26.606 € | 27.590 € | 296,28 | 309,60 | 70.800 | 873,60 | 126,00 | 6 | 7,26 | 3,48 | 44 | 50 | 936 | 76 | 54 |
| ASL8213 | 10.062 € | 10.578 € | 94,07 | 98,30 | 25.600 | 218,40 | 31,60 | 2 | 2,42 | 1,16 | 39 | 45 | 280 | 54 | 42 |
| ASL8214 | 11.109 € | 11.624 € | 98,79 | 103,23 | 23.600 | 291,20 | 42,00 | 2 | 2,42 | 1,16 | 39 | 45 | 312 | 54 | 42 |
| ASL8223 | 16.934 € | 17.664 € | 188,15 | 196,60 | 51.200 | 436,80 | 63,20 | 4 | 4,84 | 2,32 | 42 | 48 | 560 | 54 | 42 |
| ASL8224 | 18.776 € | 19.506 € | 197,49 | 206,37 | 47.200 | 582,40 | 84,00 | 4 | 4,84 | 2,32 | 42 | 48 | 624 | 76 | 54 |
| ASL8233 | 24.002 € | 24.985 € | 282,13 | 294,81 | 76.800 | 655,20 | 94,80 | 6 | 7,26 | 3,48 | 44 | 50 | 840 | 76 | 54 |
| ASL8234 | 26.819 € | 27.803 € | 296,28 | 309,60 | 70.800 | 873,60 | 126,00 | 6 | 7,26 | 3,48 | 44 | 50 | 936 | 76 | 54 |
| ASL8243 | 33.340 € | 34.801 € | 376,20 | 393,11 | 102.400 | 873,60 | 126,40 | 8 | 9,68 | 1,64 | 45,5 | 51,5 | 1120 | 89 | 67 |
| ASL8244 | 37.024 € | 38.484 € | 394,98 | 412,73 | 94.400 | 1.164,80 | 168,00 | 8 | 9,68 | 1,64 | 45,5 | 51,5 | 1248 | 89 | 67 |
| ASL8253 | 40.459 € | 42.172 € | 470,28 | 491,41 | 128.000 | 1.092,00 | 158,00 | 10 | 12,01 | 5,80 | 46 | 52 | 1400 | 89 | 67 |
| ASL8254 | 45.118 € | 46.831 € | 493,77 | 515,96 | 118.000 | 1.456,00 | 210,00 | 10 | 12,01 | 5,80 | 46 | 52 | 1560 | 2x76 | 54 |
| ASL8263 | 47.576 € | 49.544 € | 564,35 | 589,71 | 153.600 | 1.310,40 | 189,60 | 12 | 14,52 | 6,96 | 47 | 53 | 1680 | 2x76 | 54 |
| ASL8264 | 53.212 € | 55.179 € | 592,56 | 619,19 | 141.600 | 1.747,20 | 252,00 | 12 | 14,52 | 6,96 | 47 | 53 | 1872 | 2x89 | 67 |

Datos y precios

Ø 800 mm

| Modelo | Flujo Horiz. | Flujo Vert. | R449A | R134A | Caudal aire m³/h | Superf. m² | Vol. interno dm³ | Nº Vent. | Abs. nominal A | Cons. nominal Kw | Nivel Sonoro | | Peso Kg | IN Ø" | OUT Ø" |
|----------------------|--------------|-------------|------------------------|------------------------|------------------------|---------------|------------------------|----------|-------------------|---------------------|--------------|------|------------|----------|-----------|
| | P.V.P. | P.V.P. | Cap. Nominal ΔT=15K | Cap. Nominal ΔT=15K | | | | | | | 10 m | 5 m | | | |
| 12 polos - Δ 430 rpm | | | | | | | | | | | | | | | |
| ASLL8113 | 5.339 € | 5.688 € | 38,18 | 39,90 | 10.000 | 109,20 | 15,80 | 1 | 0,59 | 0,22 | 31 | 37 | 140 | 42 | 28 |
| ASLL8114 | 5.831 € | 6.180 € | 41,03 | 42,87 | 9.600 | 145,60 | 21,00 | 1 | 0,59 | 0,22 | 31 | 37 | 156 | 42 | 28 |
| ASLL8123 | 9.123 € | 9.601 € | 76,36 | 79,79 | 20.000 | 218,40 | 31,60 | 2 | 1,18 | 0,44 | 34 | 40 | 280 | 54 | 42 |
| ASLL8124 | 10.092 € | 10.570 € | 82,06 | 85,75 | 19.200 | 291,20 | 42,00 | 2 | 1,18 | 0,44 | 34 | 40 | 312 | 54 | 42 |
| ASLL8133 | 12.978 € | 13.583 € | 114,45 | 119,60 | 30.000 | 327,60 | 47,40 | 3 | 1,77 | 0,66 | 35 | 41 | 420 | 54 | 42 |
| ASLL8134 | 14.381 € | 14.986 € | 123,00 | 128,53 | 28.800 | 436,80 | 63,00 | 3 | 1,77 | 0,66 | 35 | 41 | 468 | 67 | 42 |
| ASLL8143 | 16.670 € | 17.400 € | 152,64 | 159,50 | 40.000 | 436,80 | 63,20 | 4 | 2,36 | 0,88 | 37 | 43 | 560 | 67 | 42 |
| ASLL8144 | 18.512 € | 19.242 € | 164,03 | 171,40 | 38.400 | 582,40 | 84,00 | 4 | 2,36 | 0,88 | 37 | 43 | 624 | 67 | 42 |
| ASLL8153 | 20.228 € | 21.085 € | 190,82 | 199,39 | 50.000 | 546,00 | 79,00 | 5 | 2,95 | 1,10 | 38 | 44 | 700 | 76 | 54 |
| ASLL8154 | 22.558 € | 23.415 € | 205,06 | 214,27 | 48.000 | 728,00 | 105,00 | 5 | 2,95 | 1,10 | 38 | 44 | 780 | 76 | 54 |
| ASLL8163 | 23.789 € | 24.771 € | 229,00 | 239,29 | 60.000 | 655,20 | 94,80 | 6 | 3,54 | 1,32 | 39 | 45 | 840 | 76 | 54 |
| ASLL8164 | 26.606 € | 27.590 € | 246,09 | 257,15 | 57.600 | 873,60 | 126,00 | 6 | 3,54 | 1,32 | 39 | 45 | 936 | 76 | 54 |
| ASLL8213 | 10.062 € | 10.578 € | 76,36 | 79,79 | 20.000 | 218,40 | 31,60 | 2 | 1,18 | 0,44 | 34 | 40 | 280 | 54 | 42 |
| ASLL8214 | 11.109 € | 11.624 € | 82,06 | 85,75 | 19.200 | 291,20 | 42,00 | 2 | 1,18 | 0,44 | 34 | 40 | 312 | 54 | 42 |
| ASLL8223 | 16.934 € | 17.664 € | 152,64 | 159,50 | 40.000 | 436,80 | 63,20 | 4 | 2,36 | 0,88 | 37 | 43 | 560 | 54 | 42 |
| ASLL8224 | 18.776 € | 19.506 € | 164,03 | 171,40 | 38.400 | 582,40 | 84,00 | 4 | 2,36 | 0,88 | 37 | 43 | 624 | 76 | 54 |
| ASLL8233 | 24.002 € | 24.985 € | 229,00 | 239,29 | 60.000 | 655,20 | 94,80 | 6 | 3,54 | 1,32 | 39 | 45 | 840 | 76 | 54 |
| ASLL8234 | 26.819 € | 27.803 € | 246,09 | 257,15 | 57.600 | 873,60 | 126,00 | 6 | 3,54 | 1,32 | 39 | 45 | 936 | 76 | 54 |
| ASLL8243 | 33.340 € | 34.801 € | 305,27 | 318,99 | 80.000 | 873,60 | 126,40 | 8 | 4,72 | 1,76 | 40,5 | 46,5 | 1120 | 89 | 67 |
| ASLL8244 | 37.024 € | 38.484 € | 328,05 | 342,80 | 76.800 | 1.164,80 | 168,00 | 8 | 4,72 | 1,76 | 40,5 | 46,5 | 1248 | 89 | 67 |
| ASLL8253 | 40.459 € | 42.172 € | 381,63 | 398,78 | 100.000 | 1.092,00 | 158,00 | 10 | 5,90 | 2,20 | 41 | 47 | 1400 | 89 | 67 |
| ASLL8254 | 45.118 € | 46.831 € | 410,11 | 428,54 | 96.000 | 1.456,00 | 210,00 | 10 | 5,90 | 2,20 | 41 | 47 | 1560 | 2x76 | 54 |
| ASLL8263 | 47.576 € | 49.544 € | 457,99 | 478,58 | 120.000 | 1.310,40 | 189,60 | 12 | 7,08 | 2,64 | 42 | 48 | 1680 | 2x76 | 54 |
| ASLL8264 | 53.212 € | 55.179 € | 492,17 | 514,29 | 115.200 | 1.747,20 | 252,00 | 12 | 7,08 | 2,64 | 42 | 48 | 1872 | 2x89 | 67 |
| 12 polos - Y 340 rpm | | | | | | | | | | | | | | | |
| ASLL8113 | 5.339 € | 5.688 € | 32,40 | 33,85 | 8.000 | 109,20 | 15,80 | 1 | 0,28 | 0,13 | 28 | 34 | 140 | 42 | 28 |
| ASLL8114 | 5.831 € | 6.180 € | 33,73 | 35,25 | 7.400 | 145,60 | 21,00 | 1 | 0,28 | 0,13 | 28 | 34 | 156 | 42 | 28 |
| ASLL8123 | 9.123 € | 9.601 € | 64,70 | 67,61 | 16.000 | 218,40 | 31,60 | 2 | 0,56 | 0,26 | 31 | 37 | 280 | 54 | 42 |
| ASLL8124 | 10.092 € | 10.570 € | 67,46 | 70,49 | 14.800 | 291,20 | 42,00 | 2 | 0,56 | 0,26 | 31 | 37 | 312 | 54 | 42 |
| ASLL8133 | 12.978 € | 13.583 € | 97,10 | 101,46 | 24.000 | 327,60 | 47,40 | 3 | 0,84 | 0,39 | 32 | 38 | 420 | 54 | 42 |
| ASLL8134 | 14.381 € | 14.986 € | 101,19 | 105,74 | 22.200 | 436,80 | 63,00 | 3 | 0,84 | 0,39 | 32 | 38 | 468 | 67 | 42 |
| ASLL8143 | 16.670 € | 17.400 € | 129,41 | 135,22 | 32.000 | 436,80 | 63,20 | 4 | 1,12 | 0,52 | 34 | 40 | 560 | 67 | 42 |
| ASLL8144 | 18.512 € | 19.242 € | 134,92 | 140,99 | 29.600 | 582,40 | 84,00 | 4 | 1,12 | 0,52 | 34 | 40 | 624 | 67 | 42 |
| ASLL8153 | 20.228 € | 21.085 € | 161,80 | 169,07 | 40.000 | 546,00 | 79,00 | 5 | 1,40 | 0,65 | 35 | 41 | 700 | 76 | 54 |
| ASLL8154 | 22.558 € | 23.415 € | 168,57 | 176,14 | 37.000 | 728,00 | 105,00 | 5 | 1,40 | 0,65 | 35 | 41 | 780 | 76 | 54 |
| ASLL8163 | 23.789 € | 24.771 € | 194,11 | 202,83 | 48.000 | 655,20 | 94,80 | 6 | 1,68 | 0,78 | 36 | 42 | 840 | 76 | 54 |
| ASLL8164 | 26.606 € | 27.590 € | 202,30 | 211,39 | 44.400 | 873,60 | 126,00 | 6 | 1,68 | 0,78 | 36 | 42 | 936 | 76 | 54 |
| ASLL8213 | 10.062 € | 10.578 € | 64,70 | 67,61 | 16.000 | 218,40 | 31,60 | 2 | 0,56 | 0,26 | 31 | 37 | 280 | 54 | 42 |
| ASLL8214 | 11.109 € | 11.624 € | 67,46 | 70,49 | 14.800 | 291,20 | 42,00 | 2 | 0,56 | 0,26 | 31 | 37 | 312 | 54 | 42 |
| ASLL8223 | 16.934 € | 17.664 € | 129,41 | 135,22 | 32.000 | 436,80 | 63,20 | 4 | 1,12 | 0,52 | 34 | 40 | 560 | 54 | 42 |
| ASLL8224 | 18.776 € | 19.506 € | 134,92 | 140,99 | 29.600 | 582,40 | 84,00 | 4 | 1,12 | 0,52 | 34 | 40 | 624 | 76 | 54 |
| ASLL8233 | 24.002 € | 24.985 € | 194,11 | 202,83 | 48.000 | 655,20 | 94,80 | 6 | 1,68 | 0,78 | 36 | 42 | 840 | 76 | 54 |
| ASLL8234 | 26.819 € | 27.803 € | 202,30 | 211,39 | 44.400 | 873,60 | 126,00 | 6 | 1,68 | 0,78 | 36 | 42 | 936 | 76 | 54 |
| ASLL8243 | 33.340 € | 34.801 € | 258,81 | 270,44 | 64.000 | 873,60 | 126,40 | 8 | 2,24 | 1,04 | 37,5 | 43,5 | 1120 | 89 | 67 |
| ASLL8244 | 37.024 € | 38.484 € | 269,76 | 281,88 | 59.200 | 1.164,80 | 168,00 | 8 | 2,24 | 1,04 | 37,5 | 43,5 | 1248 | 89 | 67 |
| ASLL8253 | 40.459 € | 42.172 € | 323,52 | 338,06 | 80.000 | 1.092,00 | 158,00 | 10 | 2,80 | 1,30 | 38 | 44 | 1400 | 89 | 67 |
| ASLL8254 | 45.118 € | 46.831 € | 337,22 | 352,38 | 74.000 | 1.456,00 | 210,00 | 10 | 2,80 | 1,30 | 38 | 44 | 1560 | 2x76 | 54 |
| ASLL8263 | 47.576 € | 49.544 € | 388,22 | 405,67 | 96.000 | 1.310,40 | 189,60 | 12 | 3,96 | 1,56 | 39 | 45 | 1680 | 2x76 | 54 |
| ASLL8264 | 53.212 € | 55.179 € | 404,68 | 422,87 | 88.800 | 1.747,20 | 252,00 | 12 | 3,96 | 1,56 | 39 | 45 | 1872 | 2x89 | 67 |

Opcionales

| Código | ALE PRE | ALE HYD | ALE CU | EVP FRS | CHA AISI304 | VENT EC | Código | ALE PRE | ALE HYD | ALE CU | EVP FRS | CHA AISI304 | VENT EC |
|--------|---------|---------|----------|----------|-------------|----------|--------|---------|---------|----------|----------|-------------|----------|
| 8113 | 189 € | 189 € | 2.081 € | 1.681 € | no disp | 1.696 € | 8213 | 423 € | 423 € | 3.825 € | 3.178 € | no disp | 3.393 € |
| 8114 | 318 € | 318 € | 2.611 € | 2.204 € | no disp | 1.696 € | 8214 | 532 € | 532 € | 5.067 € | 4.174 € | no disp | 3.393 € |
| 8115 | 373 € | 373 € | 3.240 € | 2.708 € | no disp | 1.696 € | 8215 | 638 € | 638 € | 6.308 € | 5.171 € | no disp | 3.393 € |
| 8123 | 427 € | 427 € | 3.868 € | 3.211 € | no disp | 3.393 € | 8223 | 746 € | 746 € | 7.550 € | 6.167 € | no disp | 6.786 € |
| 8124 | 535 € | 535 € | 5.123 € | 4.219 € | no disp | 3.393 € | 8224 | 961 € | 961 € | 10.034 € | 8.160 € | no disp | 6.786 € |
| 8125 | 645 € | 645 € | 6.379 € | 5.227 € | no disp | 3.393 € | 8225 | 1.176 € | 1.176 € | 12.517 € | 10.153 € | no disp | 6.786 € |
| 8133 | 591 € | 591 € | 5.750 € | 4.723 € | no disp | 5.089 € | 8233 | 1.069 € | 1.069 € | 11.275 € | 9.157 € | no disp | 10.178 € |
| 8134 | 754 € | 754 € | 7.634 € | 6.234 € | no disp | 5.089 € | 8234 | 1.392 € | 1.392 € | 15.000 € | 12.146 € | no disp | 10.178 € |
| 8135 | 917 € | 917 € | 9.517 € | 7.746 € | no disp | 5.089 € | 8235 | 1.715 € | 1.715 € | 18.725 € | 15.136 € | no disp | 10.178 € |
| 8143 | 754 € | 754 € | 7.634 € | 6.234 € | no disp | 6.786 € | 8243 | 1.392 € | 1.392 € | 15.000 € | 12.146 € | no disp | 13.571 € |
| 8144 | 971 € | 971 € | 10.145 € | 8.250 € | no disp | 6.786 € | 8244 | 1.822 € | 1.822 € | 19.966 € | 16.132 € | no disp | 13.571 € |
| 8145 | 1.189 € | 1.189 € | 12.656 € | 10.265 € | no disp | 6.786 € | 8245 | 2.253 € | 2.253 € | 24.932 € | 20.118 € | no disp | 13.571 € |
| 8153 | 917 € | 917 € | 9.517 € | 7.746 € | no disp | 8.482 € | 8253 | 1.715 € | 1.715 € | 18.725 € | 15.136 € | no disp | 16.964 € |
| 8154 | 1.189 € | 1.189 € | 12.656 € | 10.265 € | no disp | 8.482 € | 8254 | 2.253 € | 2.253 € | 24.932 € | 20.118 € | no disp | 16.964 € |
| 8155 | 1.461 € | 1.461 € | 15.795 € | 12.784 € | no disp | 8.482 € | 8255 | 2.791 € | 2.791 € | 31.141 € | 25.100 € | no disp | 16.964 € |
| 8163 | 1.079 € | 1.079 € | 11.401 € | 9.257 € | no disp | 10.178 € | 8263 | 2.038 € | 2.038 € | 22.449 € | 18.125 € | no disp | 20.357 € |
| 8164 | 1.406 € | 1.406 € | 15.167 € | 12.281 € | no disp | 10.178 € | 8264 | 2.683 € | 2.683 € | 29.900 € | 24.104 € | no disp | 20.357 € |
| 8165 | 1.733 € | 1.733 € | 18.934 € | 15.304 € | no disp | 10.178 € | 8265 | 3.329 € | 3.329 € | 37.349 € | 30.083 € | no disp | 20.357 € |